

# UNIVERSITY OF CALIFORNIA, LOS ANGELES PHYSICAL DESIGN FRAMEWORK

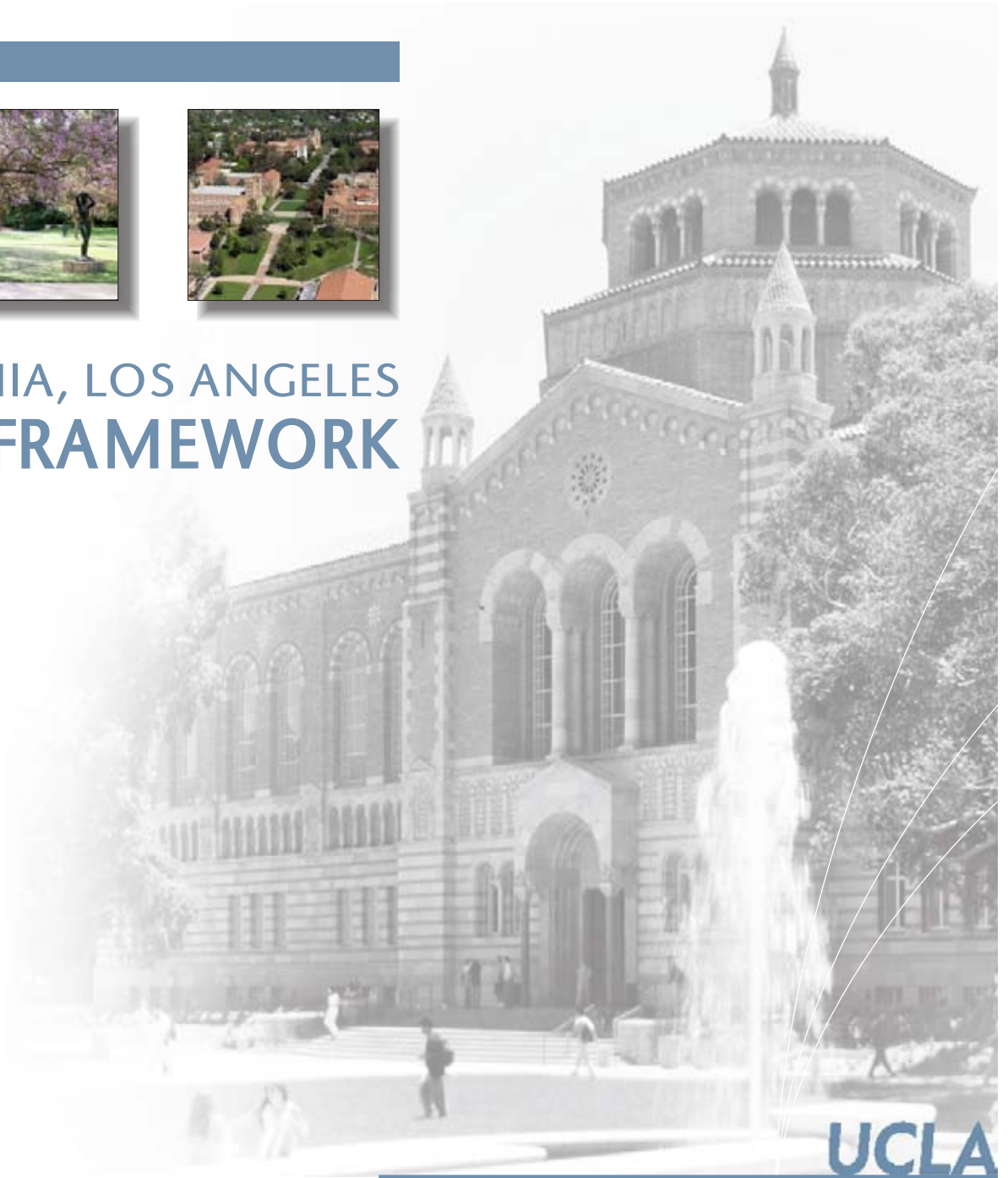

# Table of Contents

I.	Introduction	1
II.	UCLA Overview	2
III.	Long Range Development Plan (LRDP)	3
	Physical Planning Objectives	
	Campus Land Use Zones	
	Open Space	
	Circulation	
	Utility Infrastructure	
IV.	Physical Design Standards	17
	Sustainability and Green Buildings	
	Base Iconography	
	Building Materials Standards	
	Pedestrian Circulation and Campus Hardscape	
	Open Space and Landscape	
	Campus Furniture and Signage	
	Architectural Implementation	
	Site Character and Context	
	Integrated Larger Scale Imagery	
V.	Design Process and Review	31
VI.	Appendices:	32
	A. LRDP EIR Mitigation Monitoring Program	
	B. Architectural Guidelines	

## I. Introduction

The UCLA Physical Design Framework describes the approach for development of buildings, infrastructure and landscape on the campus within the context of the physical planning objectives contained in the Long Range Development Plan (LRDP). It also describes the physical design standards that guide new development to enhance the unique campus aesthetic within the constraints of a fully developed urban environment. The Framework describes the design review process that ensures that the LRDP objectives and Physical Design Standards are embodied in all new projects. The Framework will be used to ensure compatibility of new development with the existing built environment while continuing to strengthen the vibrant identity and design vernacular of the UCLA campus.

This Framework is submitted in concert with the UCLA 2009-19 Capital Financial Plan (Capital Financial Plan) that reflects key academic and strategic program goals that will be achieved through the development of projects that are consistent with the Framework. The Capital Financial Plan provides a financial framework for the campus to prioritize capital investments in support of the academic program and will be updated annually. The Capital Financial Plan describes three overarching capital strategic initiatives: Complete the seismic correction of all remaining deficient structures by 2019; Transform UCLA to a residential academic community; and Build a sustainable campus.



Wilson Plaza Looking East

## II. UCLA Overview

Established as the Southern Branch of the University of California, UCLA began by offering two-year undergraduate degrees and a Teachers Training program in 1919. Today, UCLA is the largest university within the 10-campus University of California (UC) system with approximately 39,000 undergraduate and graduate students and 20,000 staff and faculty; offering more than 318 degree programs through the College of Letters and Science and 11 professional schools: Arts and Architecture, Dentistry, Medicine, Management, Law, Education & Information, Engineering & Applied Sciences, Nursing, Public Health, Public Affairs, and Theatre, Film & Television. UCLA's medical enterprise continues to be a leader in medical education, research and service, consisting of four hospitals and several affiliated programs. In addition, the academic and research programs support over 37 established interdepartmental programs, 24 organized research units, and many interdisciplinary efforts. In recognition for its research prowess, the campus received approximately \$900 million in total research awards in 2007-08.

To enhance the academic and college experience of the students, UCLA has continued to transform into a residential campus and currently accommodates over 10,000 students on campus and approximately 2,500 in university owned off-campus housing. The addition of 2,100 beds by 2013 will further the campus' ability to provide its students with a nurturing university environment.

As an integral part of the fabric of the Los Angeles region, UCLA acts as a catalyst and a mirror of the continuously changing landscape of Southern California and the world. A physical landscape that began as chaparral covered hills, the campus has transformed into a diverse architectural setting with the dramatic Romanesque style of the historic core blending with new buildings of modern design. Accentuated by courtyards and sweeping views from Janss Steps, UCLA provides a unique visual experience worthy of a university known for its academic excellence.

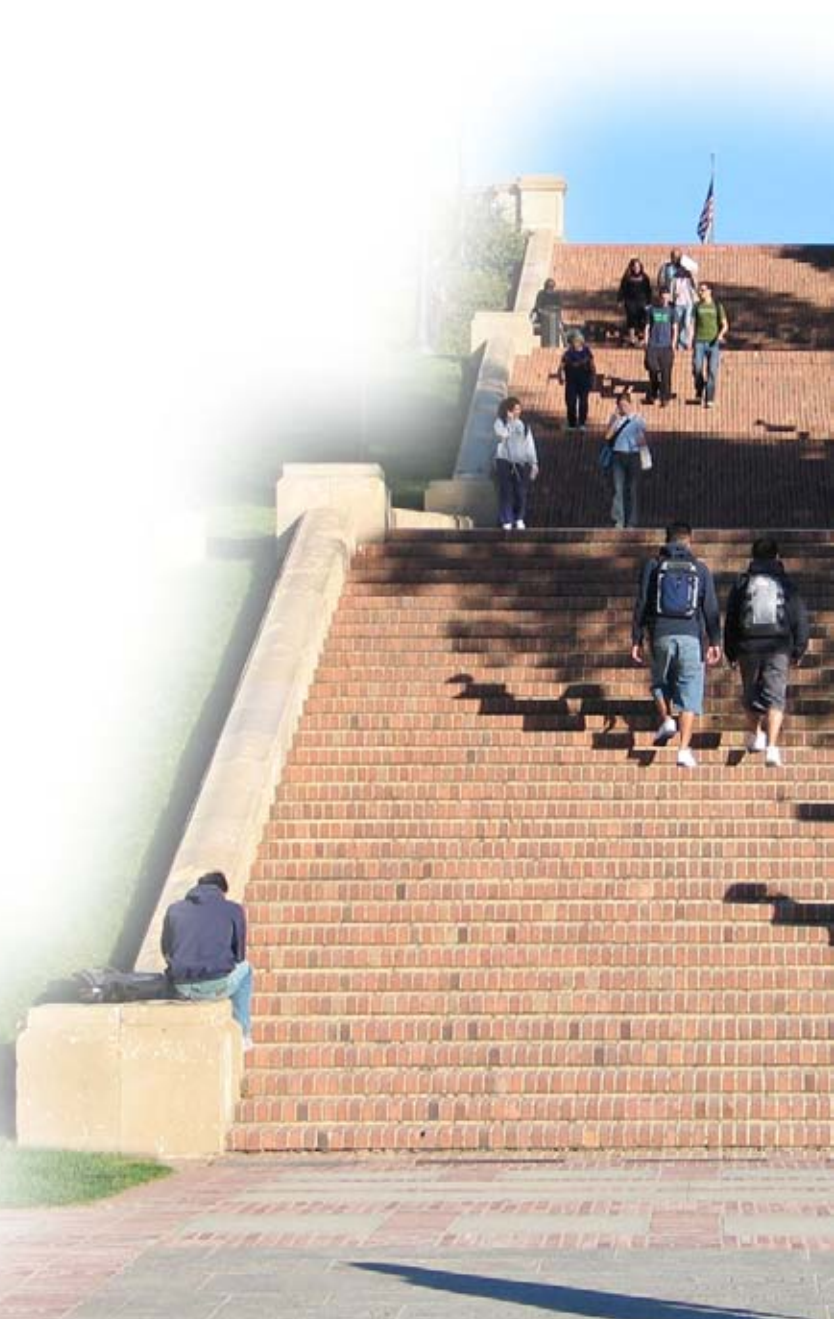

### III. Long Range Development Plan (LRDP)

The 2002 Long Range Development Plan amended in 2009 (LRDP), sets forth the overall land use plan for development of the campus through a projected horizon year of 2013. Certified in March 2009, the LRDP Environmental Impact Report (EIR) provides the environmental analysis and adopted measures to reduce environmental impacts from implementation of the LRDP. The LRDP EIR Mitigation Monitoring and Reporting Program (MMRP) listing all adopted programs, practices, procedures (PPs) and mitigation measures (MMs) applicable to campus development and operations is provided in Appendix A. Both the LRDP and LRDP EIR are available at [www.capital.ucla.edu](http://www.capital.ucla.edu).

The LRDP serves as the comprehensive policy and land use plan to guide physical development of the campus in support of its teaching, research and service missions. The LRDP includes broad land use and physical planning objectives that provide the context for physical development within the constraints of a fully developed urban environment and the capacity limitations of regional infrastructure.

The LRDP provides for the development of 1.87 million square feet and up to 25,169 parking spaces through a 2013 planning horizon. Currently, the campus has approximately 200 buildings comprising approximately 17 million gross square feet and approximately 24,000 parking spaces, accommodating the largest campus population (almost 60,000 per average weekday) on one of the smallest campuses (419 acres) in the UC system.

Enhancing its urban character, the campus' outdoor aesthetic reflects the importance of open space, with approximately 34 percent of the campus consisting of green space including courtyards gardens, recreation space, and perimeter buffer areas.

The LRDP delineates eight campus land use zones and allocates new development square footage according to campus strategic needs. These allocations are subject to forecasting uncertainty, thus, the LRDP maintains flexibility through an amendment

process to transfer square footage between zones to accommodate future development. LRDP amendments to transfer over 30,000 gsf require approval by The Regents.

Since 1990, the campus has adhered to a voluntary limit on parking (25,169 spaces) and vehicle trips (139,500 average daily trips) and has reduced its impact significantly below 1990 levels (in 2008 the campus had 24,169 parking spaces and 112,043 average daily trips) with considerable investment in on-campus student housing coupled with award winning Transportation Demand Management programs. The LRDP also incorporates provisions of the Climate Action Plan adopted in 2008 with aggressive initiatives focused upon attaining UC Policy and State greenhouse gas emissions thresholds by 2012, eight years ahead of schedule.

In 2009, the campus began a broad planning and consultation process to update its long range strategic academic plan to inform the next LRDP planning cycle. With the campus already substantially built-out, on-campus development opportunities will primarily involve new infill projects, and reconstruction and replacement of existing buildings. Given sustainability as an important strategic initiative, the campus will continue to balance the retention of open space with continued needs for new facilities.

This *Physical Design Framework* does not change the land use plan or alter the projected square footage development allocation, population estimates and institutional objectives reflected in the LRDP.

### III. Long Range Development Plan (LRDP)

#### *Physical Planning Objectives*

The LRDP delineates eight campus land use zones allocating potential new development square footage in accordance with strategic academic, research, recreation, student services, and other ancillary needs and its commitment to sustainable development balancing a myriad of competing aspirations.

The physical environment, facilities, and the quality of campus life are important factors in recruitment and retention of UCLA's students, faculty and workforce. While the campus land resources are limited, opportunities for infill and redevelopment remain. Planning for future development at UCLA continues to examine the utility and cost-effectiveness of renovating or replacing aging facilities, the constraints of a fully developed urban environment, the capacity limitations of local and regional infrastructure and the reduction of the campus' carbon footprint.



Aerial View of Janss Steps and Dickson Plaza

### III. Long Range Development Plan (LRDP)

#### *Physical Planning Objectives (Cont'd)*

The LRDP includes several institutional planning objectives organized into three categories: academic, physical, and operational. For purposes of this *Physical Design Framework*, the most relevant objectives to guide future development are:

- Maintain the integrity of the campus historic core.
  - Respect and reinforce the architectural and landscape traditions that give the campus its unique character.
  - Retain the human scale and rich landscape of the campus while enhancing its function as a mature university in a fully developed urban environment.
  - Site new buildings in locations that offer programmatic advantages due to proximity to related academic disciplines.
  - Site new building projects to ensure compatibility with existing uses and the height and massing of adjacent facilities, to the extent feasible.
  - Site and design facilities to enhance spatial development of the campus while maximizing use of limited land resources.
  - Plan, design, and implement development in a manner consistent with the UC Policy on Sustainable Practices and the UCLA Climate Action Plan.
  - Develop on-campus housing to enhance the educational experience for students and continue the evolution of UCLA from a commuter to a residential campus.
  - Continue the infill development of the UCLA campus, which reduces vehicle miles traveled and energy consumption.
  - Design future development on the southern edge of the main campus to enhance the campus interface with Westwood Village.
  - Clarify and strengthen existing pedestrian and vehicular circulation to enhance way-finding and promote safety.
  - Remain sensitive to accessibility for the disabled in the site placement and design of new buildings or the renovation, restoration, or reconstruction of existing buildings.
- 
- Aerial View of Southwest and Health Sciences Zone Looking North
- Provide a landscaped buffer along the western, northern, and eastern edges of the main campus.
  - Continue to integrate landscaped open space (including plazas, courts, gardens, walkways and recreational areas) with development, to encourage use through placement and design.
  - Provide recreational facilities for students, faculty, and staff on campus.
  - Maintain the 1990 LRDP campus parking cap of 25,169 spaces.
  - Maintain the 1990 LRDP campus vehicle trip cap of 139,500 average daily trips.
  - Develop a maximum of 1.87 million gsf of additional building space, which represents the remaining development allocation approved for the 2009 LRDP Amendment.

### III. Long Range Development Plan (LRDP)

#### Campus Land Use Zones

UCLA is a mature campus with well-established building, circulation, infrastructure, and open space patterns. While the campus functions as an integrated whole, patterns of use and adjacency have defined areas characterized by dominant uses and differing densities roughly contained within eight campus planning zones: Botanical Garden, Bridge, Campus Services, Central, Core Campus, Health Sciences, Northwest, and Southwest zones. With consideration of evolving campus development needs, the LRDP identified potential square footage allocations for each of the eight land use zones. The 2009 amendment to the LRDP increased the new development allocation by 550,000 gsf, bringing the total development square footage up to 1.87 million gsf to accommodate additional undergraduate student housing beyond the level previously contemplated in the 2002 LRDP.

The following descriptions of each campus zone provide information about the existing built environment, land uses, and potential uses for the development allocation in each zone. Future project proposals will be guided by the LRDP development objectives to ensure the best possible relationship among academic, research, and public service goals; faculty and student needs; site characteristics; and integration with the surrounding on- and off-campus communities.

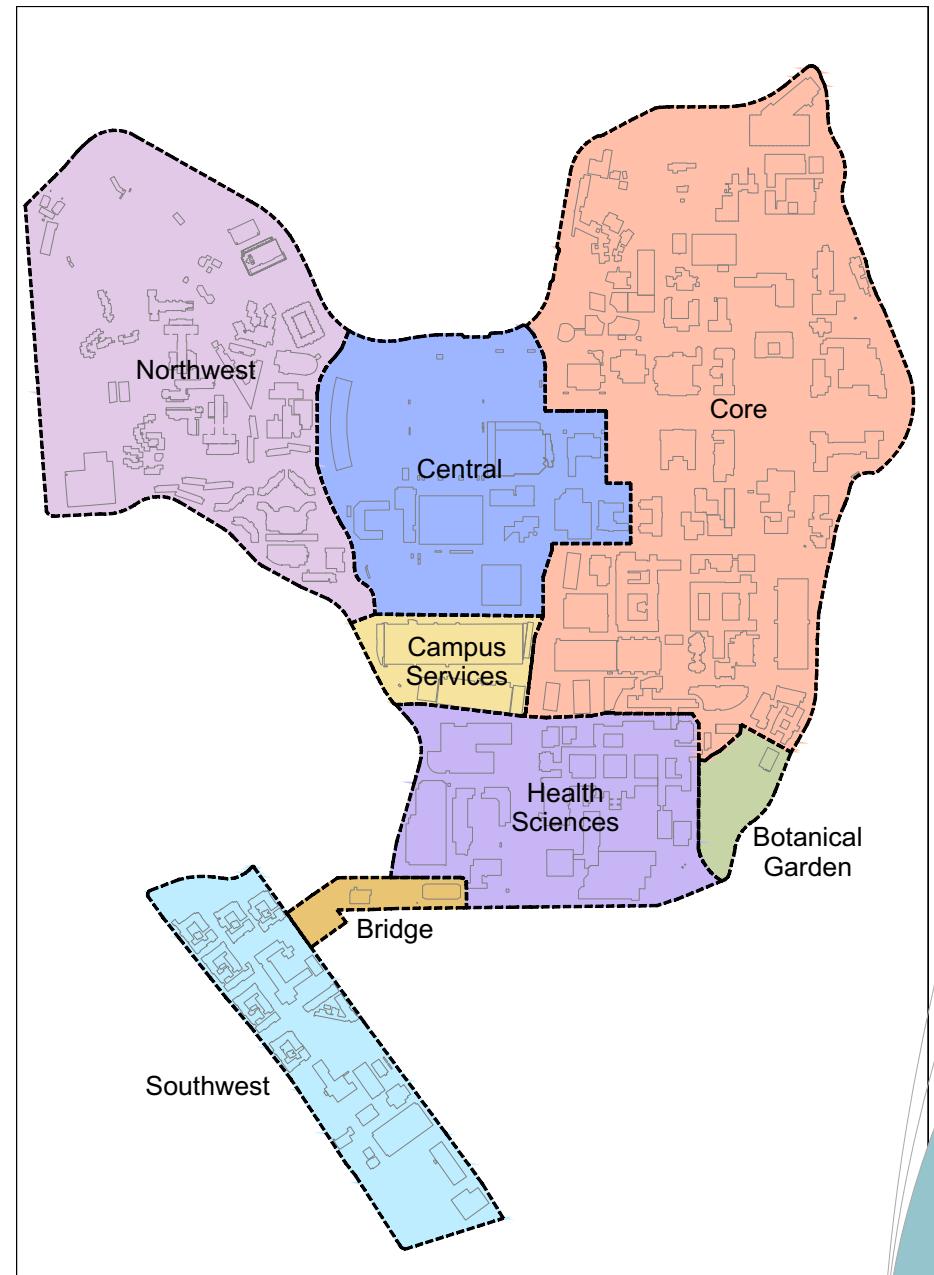

LRDP Zoning Diagram



### III. Long Range Development Plan (LRDP)

#### Northwest Zone

The 90.5-acre Northwest zone primarily accommodates undergraduate student housing, dining and support functions, university child care center, library, student services, the Sunset Canyon Recreation Center, and other recreational uses.

Major portions of the Northwest zone have been the subject of two previous settlement agreements relative to land use. One of these establishes a “benign use” zone where new uses are



LRDP Zone: Northwest Campus

restricted to open green space; landscaped buffer zones; existing buildings and parking facilities; and low-intensity, non-spectator, recreational and athletic space. The second agreement delineates a potential wildlife habitat area, where new development would require biological surveys and environmental consideration. The LRDP EIR includes adopted mitigation measures that address biological survey requirements for the 4-acre parcel as provided in Appendix A.



Rieber Terrace & Residence Hall (Photograph by Michael Moran)

### III. Long Range Development Plan (LRDP)

#### Central Zone

The 61.5-acre Central zone contains most of the campus recreational and athletic facilities and playing fields, as well as student activity centers and underground parking. The LRDP development allocation would accommodate future facility requirements for the recreation and athletics programs. With the continued growth of the on-campus residential community, recreational fields and facilities in this zone will continue to remain heavily utilized by the campus community and opportunities to enhance utilization through operational improvements continue to be explored.

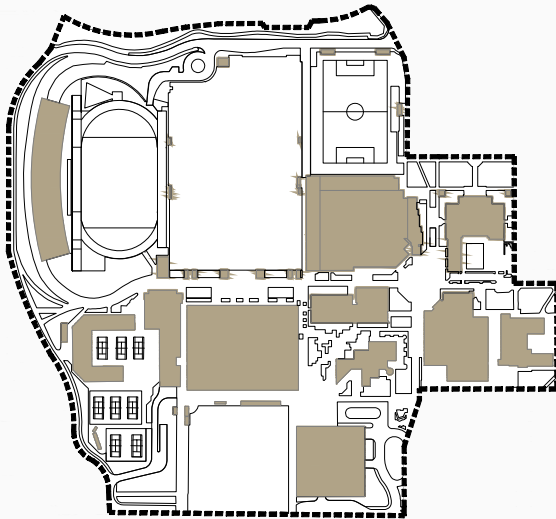

LRDP Zone: Central Campus

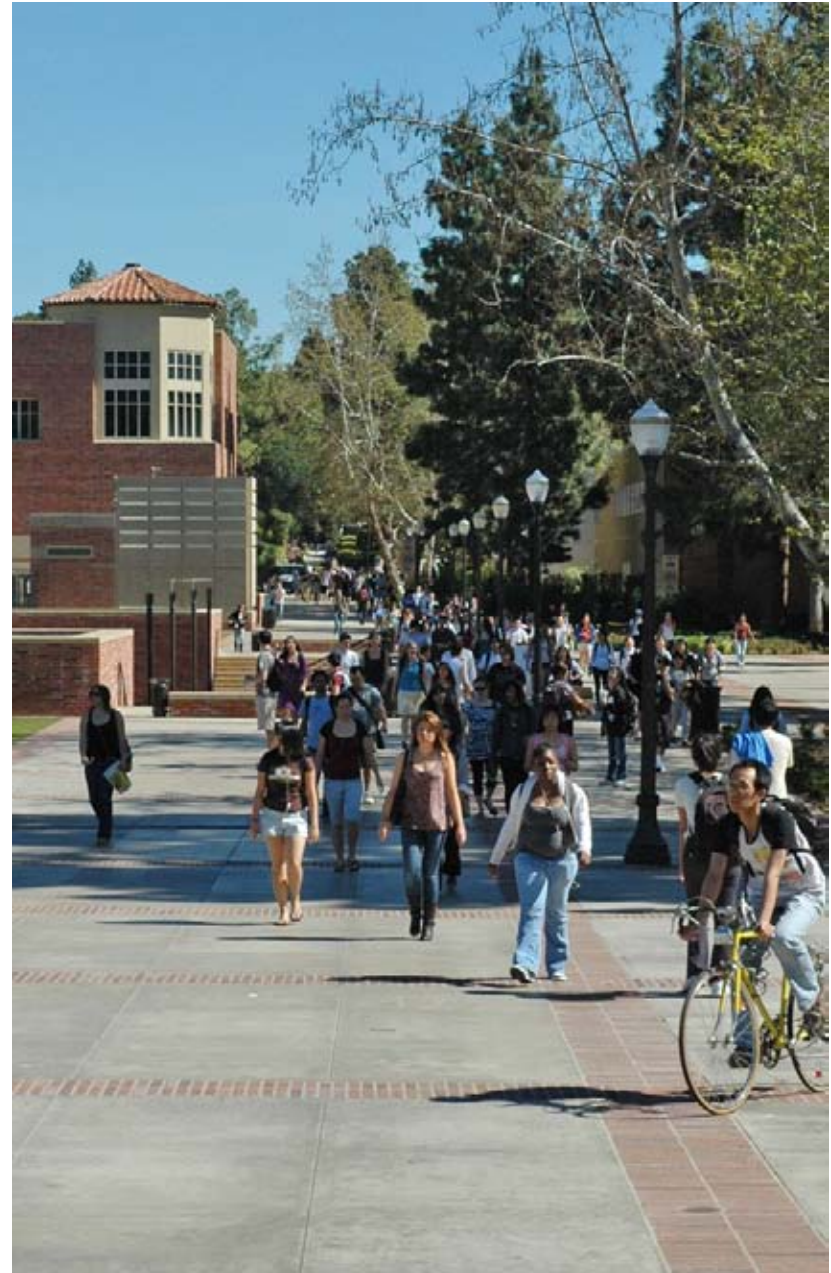

Bruin Walk

### III. Long Range Development Plan (LRDP)

#### Core Zone

The Core Campus zone, which totals 158 acres, contains the campus historic core featuring the original campus buildings and associated open areas. This zone accommodates the primary academic, research, library, cultural, professional school, and administrative facilities of the campus, the University residence, and elementary school. Land uses in this zone also include several parking structures, open landscaped courtyards, and preserves that have been developed to an exceptional level of spatial and aesthetic excellence holding cherished places in campus history and tradition.

The LRDP development allocation for the Core Campus zone would accommodate future facility requirements of the primary academic, research, library, and administrative uses in the zone to meet the needs of the College of Letters and Science, libraries, and professional school programs, which include the arts, education, engineering, and public policy. Development objectives focused on the preservation of the historic core, courtyards, and plazas are fundamental to any new development in this zone.

The Core zone contains the Stone Canyon Creek area, identified as a “preserve” in the LRDP, where any potential development would require biological resource surveys. The LRDP EIR includes adopted mitigation measures that address biological survey requirements for the Stone Canyon Creek area as provided in Appendix A.

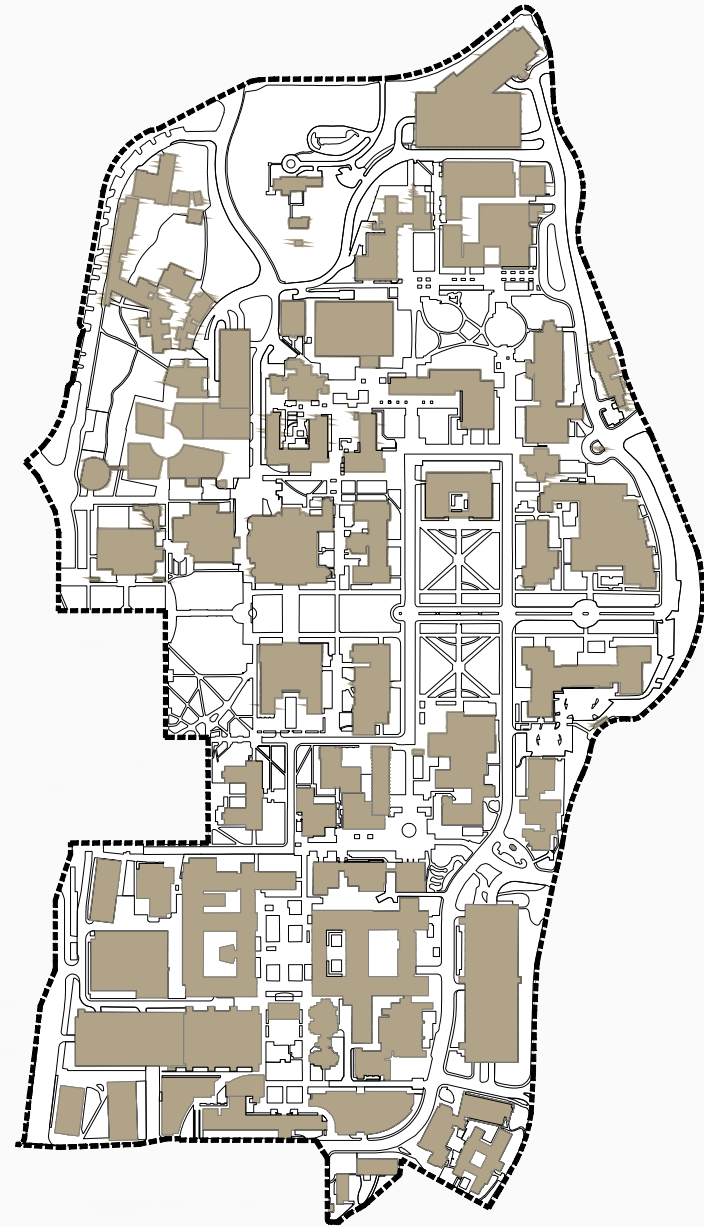

LRDP Zone: Core Campus

### III. Long Range Development Plan (LRDP)

#### Campus Services Zone

The Campus Services zone, which is approximately 15.3 acres, is located in a centralized portion of the main campus. Land uses in this zone include the Cogeneration Plant, campus fleet, parking and transportation services, Facilities Management, EH&S, UCPD, and other administrative support units. Future development within this zone would be consistent with the existing service-related uses.

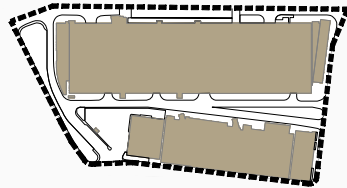

LRDP Zone: Campus Services



Facilities Management Building (Cogeneration Plant)

#### Bridge Zone

The five-acre Bridge zone forms a physical land connection between the main campus zones and the Southwest zone and contains a mixture of existing uses including health sciences administrative and research support, university extension, faculty apartments, and open space. With proximity to the existing Medical Plaza Ambulatory Care Center, the development allocation would provide for potential growth in ambulatory patient care and associated clinical research facilities. Physical development objectives pertaining to the interface between the campus and Westwood Village and provision of open space would guide future development in this zone.

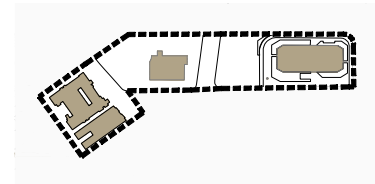

LRDP Zone: Bridge



Aerial View of Bridge Zone

### III. Long Range Development Plan (LRDP)

#### Health Sciences Zone

The Health Sciences zone, which is approximately 46.8 acres, accommodates the recently completed Ronald Reagan/UCLA Medical Center, the health sciences professional schools, medical laboratory and research facilities, the Stein Eye Research Center, the Semel Neuropsychiatric Institute, the UCLA Medical Plaza outpatient facilities, and parking. Future development in this zone would provide for renewal and replacement of facilities, including the pending seismic renovation of the Center for the Health Sciences (CHS), to support the growth of the medical enterprise.

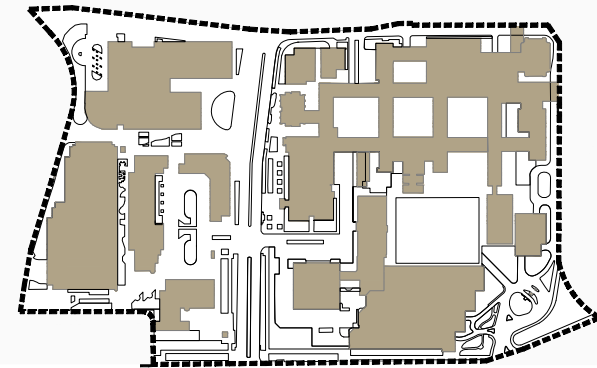

LRDP Zone: Health Sciences



Ronald Reagan UCLA Medical Center

### III. Long Range Development Plan (LRDP)

#### **Botanical Zone**

The seven-acre Botanical Garden zone, located at the Southeast portion of the main campus, contains the Mildred E. Mathias Botanical Garden (“Botanical Garden”). Open to the public, the Botanical Garden contains a recently completed Plant Growth Center supporting research in the life and medical sciences. The Botanical Garden is identified as a campus Preserve and no future development is anticipated within this zone under the LRDP.

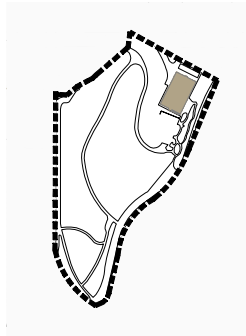

LRDP Zone: Botanical Garden

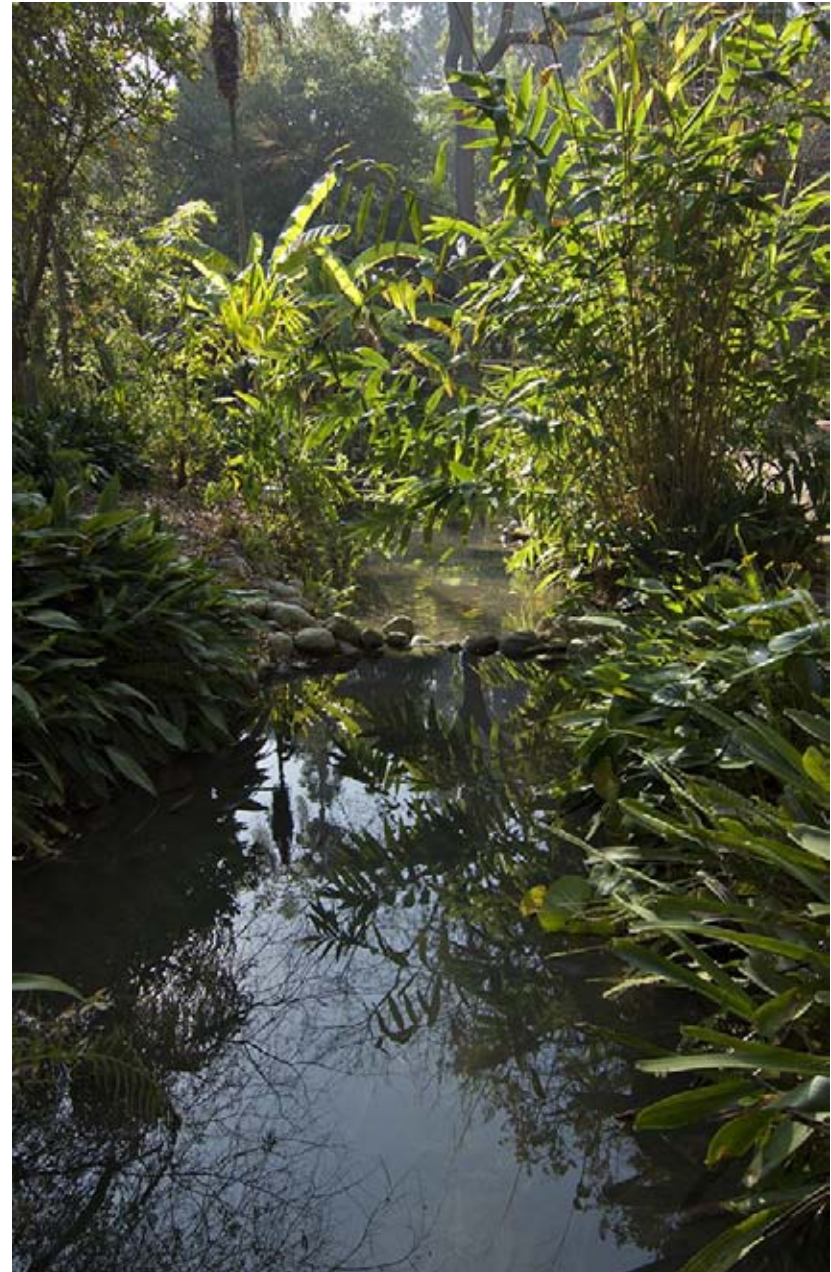

Mildred Mathias Botanical Garden

### III. Long Range Development Plan (LRDP)

#### Southwest Zone

The 35.5-acre Southwest zone accommodates a mixture of uses including graduate student housing, rehabilitation, outpatient medical uses, academic, research, administrative uses, and parking. Anticipated development within this zone includes additional graduate student housing. In addition, the Southwest zone includes surface parking lot 36 that is a significant remaining land resource for high density development along the Wilshire Boulevard Corridor. This could accommodate transit oriented housing and mixed uses planned in conjunction with potential future Westside subway proposals.

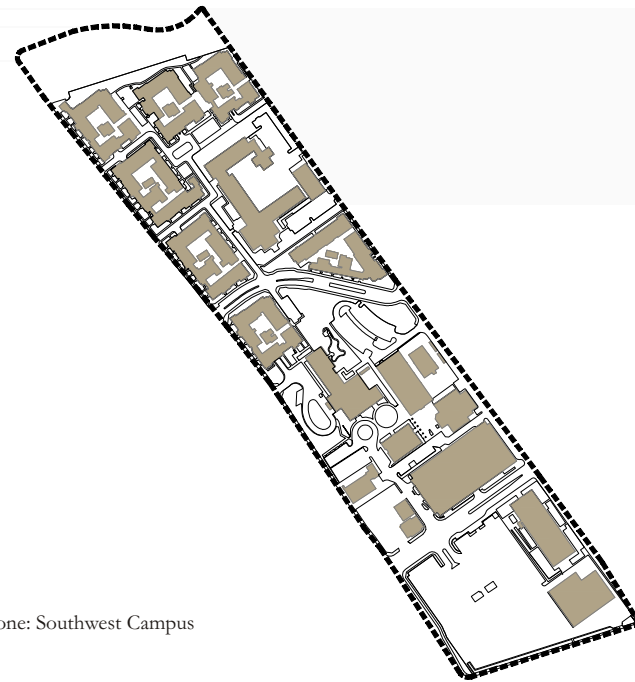

LRDP Zone: Southwest Campus







Weyburn Terrace Graduate Student Housing (Photograph by Arden Photography)

### III. Long Range Development Plan (LRDP)

#### Open Space

Open space is an essential component of the aesthetic and social life of the campus. Of the total campus area of 419 acres, approximately 142 acres, or 34 percent, consists of green space. Landscaped buffer areas surround the northern, eastern, and western boundaries of the main campus, whereas the interior of campus contains open space preserves, courtyards, plazas, gardens, campus entries, and recreational areas. The classification of open space falls into four categories:

-  Open Spaces Preserves
-  Open Spaces Recreational
-  Open Spaces Formal
-  Campus Entries & Perimeter Buffer Areas



Open Space in Campus: South of Janss Steps

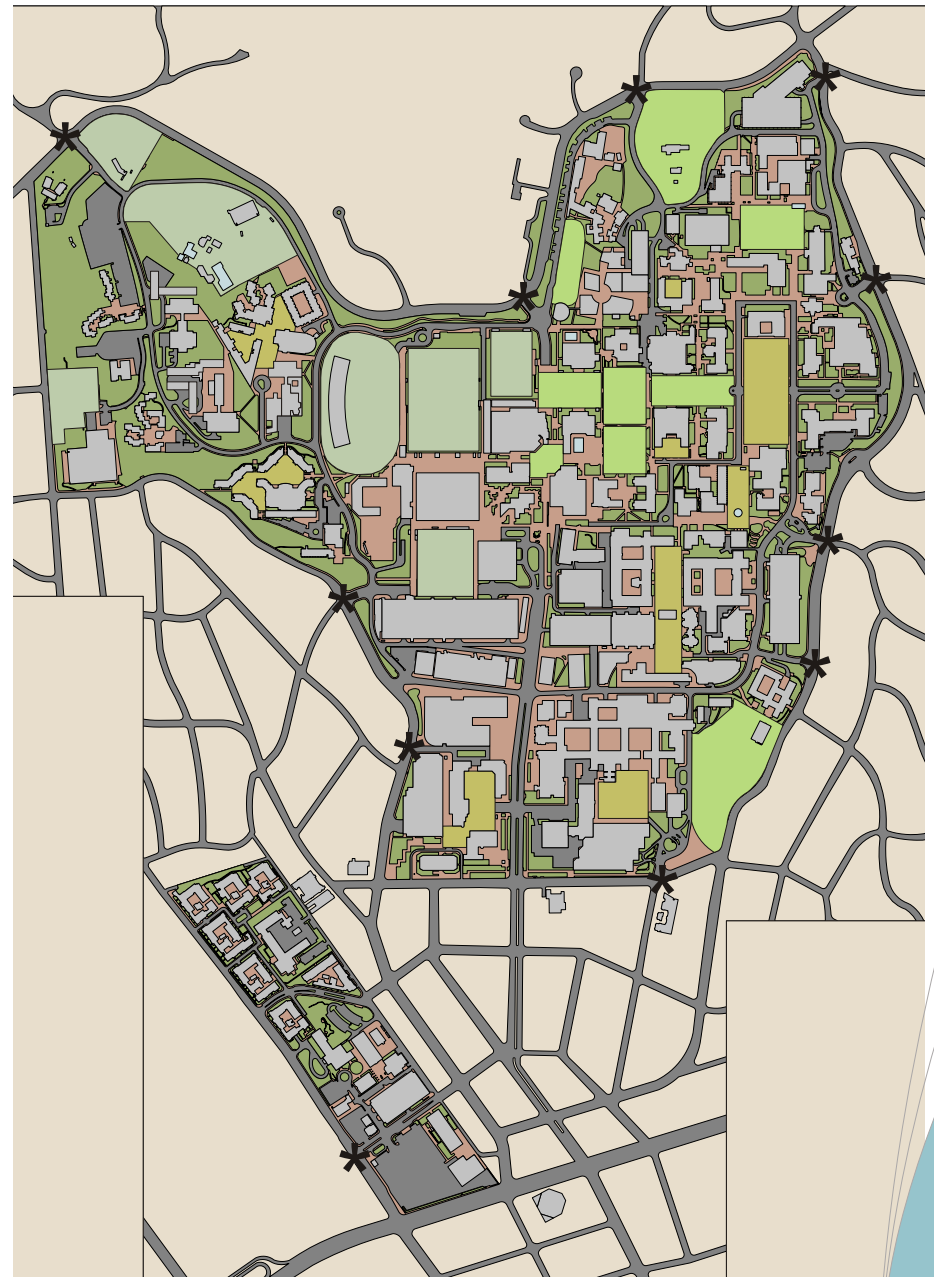

Open Space Diagram



### III. Long Range Development Plan (LRDP)



Murphy Sculpture Garden



Intramural Field



Dickson Court



UCLA Entry from Hilgard

#### Open Space (Cont'd)

- **Preserves** - Several campus open spaces have been developed to an exceptional level of spatial and aesthetic excellence or hold cherished places in campus history and tradition. Designated as Preserves, these areas include Dickson Plaza, Wilson Plaza, Janss Steps, the Mathias Botanical Garden, the Murphy Sculpture Garden, the University Residence, Stone Canyon Creek Area, Meyerhoff Park, and Bruin Plaza.
- **Recreational Open Areas** - Recreational open areas are important to the health of the campus community and the quality of campus life. Major recreational areas located in the Central and Northwest zones of campus include the Sunset Canyon Recreation Area, the Intramural Field, Drake Stadium, North Athletic Field, Spaulding Field, and the Easton Softball Stadium. The Intramural Field, North Athletic Field, and Wilson Plaza cover subterranean parking constructed in the last decade.
- **Formal Open Areas** - Other highly valued formal courtyards and plazas are designated as formal open areas, including the Court of Sciences, Dickson Court, the Rolfe Sculpture Garden, the Inverted Fountain, and several smaller courtyards and plazas. These smaller formal areas have been incorporated into the hardscape adjacent to academic and health sciences buildings.
- **Campus Entries and Perimeter Buffer Areas** - Campus entries also function as open areas that interface with off-campus uses and are marked with landscape monuments of brick or stone. The major southern entry to the campus functions as the campus "Gateway" and is located at the intersection of Le Conte Avenue and Westwood Plaza. Landscaped buffer areas provide open space and a visual separation between the campus and the urban areas on the north, west, and east boundaries of the campus. Maintenance of these buffer areas is a planning principle of the LRDP.

### III. Long Range Development Plan (LRDP)

#### *Circulation*

The on-campus circulation system is organized to facilitate on-campus travel, separating vehicles from pedestrians as much as possible. The system limits vehicular travel to the peripheral loop road (Charles E. Young Drive) and access to parking structures. Roads in the central portion of campus are limited to emergency and service vehicles and to provide proximate parking for the disabled. Well developed pedestrian pathways continue to be enhanced in conjunction with new development to improve way-finding and safety.



Westwood Plaza

#### *Utility Infrastructure*

The utility infrastructure and distribution systems (electricity, gas, heating and cooling, water, sanitary sewer, storm drain, telephone, telecommunications, and waste disposal) that serve the campus are continually evaluated and upgraded in conjunction with proposed development in order to ensure adequate facilities and services. Ongoing resource conservation programs have substantially reduced utility consumption and significant additional reductions will be achieved in conjunction with the campus' Climate Action Plan that targets a reduction in greenhouse gas emissions to 1990 levels by 2012.



Cogeneration Plant

## IV. Physical Design Standards

The UCLA Physical Design Framework outlines an overarching vision for creating a physical environment that supports the academic mission and a unique sense of place for the campus.

This Framework establishes the criteria the campus will use to judge the success of proposed projects with regard to planning and design goals. This document will be used regularly by campus planners, architects, and others to guide the effective incorporation of these goals into all projects that modify the built environment. It defines how LRDP planning goals can be met by applying the campus physical design standards, using best practices in design and learning from successful models

represented by existing campus buildings.

Since the early 1990's, UCLA has been consistently approaching development of the campus with an eye toward integrating new buildings in a manner which respects and connects with the original design intent adopted when the campus was established. These Physical Design Standards provide the more detailed design criteria to be considered while also reflecting the broader LRDP physical planning objectives. The Architectural Guidelines (Appendix B) establish campus standards for the selection of materials, colors, signage, external furniture, and hardscape that comprise the look and feel of the physical environment.



Rendering of 1935 Master Plan

## IV. Physical Design Standards

### *Sustainability and Green Buildings*

The UC Sustainability Policy (Policy) sets aggressive goals for the ten UC campuses to continue to reduce their carbon footprints. These goals present a challenge for UCLA as the campus expands and demand for energy increases through growth in the use of technology. Incorporating energy efficiency into new buildings and renovations as part of the Green Building Program has allowed UCLA to continue to reduce the amount of energy used on a square-foot basis, despite overall campus growth.

All UCLA projects are designed to comply with the requirements of the Policy. The Policy adopts green building standards using the Leadership in Energy and Environmental Design (LEED) rating system and includes stringent energy conservation measures. The LEED Rating System, developed by the U.S. Green Building Council (USGBC), provides standards for new construction (NC) and renovation (CI) projects. UCLA is committed to achieving a minimum LEED Silver certification for all new construction and major renovation projects. The Policy also requires all projects, other than acute-care facilities, to outperform the required provisions of the California Energy Code (Title 24) energy-efficiency standards by at least 20 percent and register with the Savings By Design Program offered by the local utility provider. Campus Mechanical, electrical, and plumbing (MEP) design standards reflect green building requirements and are provided to the design professional to ensure that projects incorporate appropriate consideration of conservation and utility infrastructure capacity.

LEED credit substantiation has been developed for a number of sustainable site and innovation in design measures that would be applicable to many individual projects. These relate to the existing land use policies, transportation, and energy efficiency programs already existing on the campus. Capital Programs would work with design professionals on a project by project

basis to ensure that these programs are incorporated into the building design to the maximum extent feasible.

Individual projects include a focused effort to incorporate a variety of green building measures in a holistic manner. For example, LaKretz Hall is a LEED Silver building that is constructed above a 5,000,000 gallon Thermal Energy Storage tank that provides chilled water reserves for the campus that are generated at off-peak hours. The development on this property represents a density increase that reduces overall land impacts on the campus. Daylighting strategies incorporated into the building include the use of solar shading devices at the glazing to reduce heat load and natural ventilation operations that significantly contribute to reduced energy demands. Green building materials that have been incorporated into LaKretz Hall include rapidly renewable woods, high recycled content materials, and low-emitting finishes to improve indoor air quality.

The *Capital Financial Plan* that accompanies this *Physical Design Framework* provides a more comprehensive description of campus sustainability initiatives.

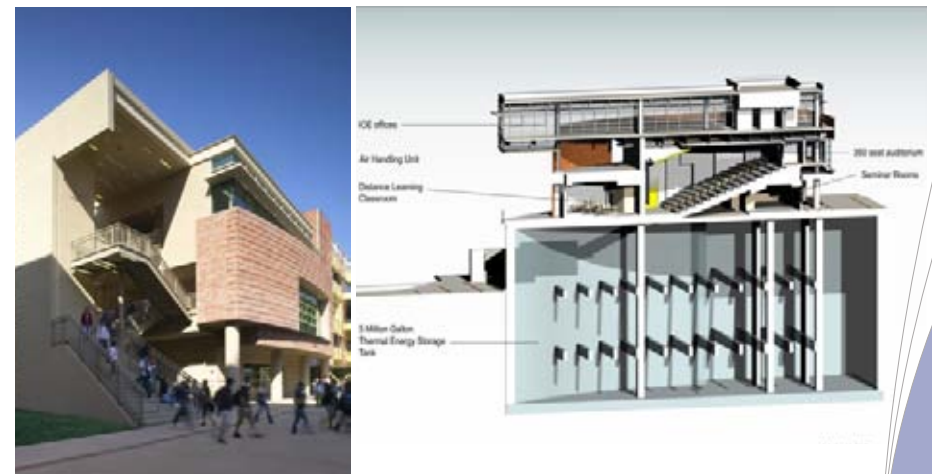

LaKretz Hall

## IV. Physical Design Standards

### Base Iconography

In 1927, the campus plan was laid out on a plateau at the western edge of an arroyo that ran from north to south. George Kelham, the supervising architect, placed the entrance on a strong east-west centerline thus creating an order based on symmetry with the buildings facing each other across a generous public plaza. The architectural style chosen was the Italian Romanesque (dating between the 9<sup>th</sup> to 12<sup>th</sup> centuries) from the Lombardy region that is distinguished by the use of brick and terra cotta that gives the walls a pleasing color scheme of red-brown and cream. As the Southern Branch of the University, no doubt the architects were looking at the similarities that the Los Angeles climate had to that of the Mediterranean and thought that the Italian Romanesque seemed more appropriate than the collegiate gothic of English universities such as Oxford or Cambridge. The first building campaign led by Kelham and executive architect David Allison (Allison and Allison) came to an end around 1932.

Built in 1929, Royce Hall is the most recognizable symbol of UCLA, with its front façade consisting of a two-story portico and flanking towers modeled after the famous Lombard church of Sant' Ambrogio in Milan. Directly opposite Royce Hall is the dramatic Powell Library that was completed in 1930. The large fenestration of the upper floor marks the main reading room that runs the entire length of the building with its high ceiling space. Further east of Royce and Powell are Haines Hall and the Humanities Building; two Italian Romanesque buildings that complete the strong composition of Dickson Plaza and the historic core of the campus. A dense pattern of brick woven with buff concrete comprises the paved areas of this large public space and the complementary color of the green grass areas sets off the richness of the brick red hues of the façades.

The stunning quality of this exterior space and four original buildings form the base iconography of the campus. The combination of the landscape, hardscape, and architecture is one

of the most striking visual experiences on campus and it becomes what most people think of as the heart of UCLA. The historic core has provided inspiration to young visitors in awe of a place of learning, motivation to those who study or work on campus, and lasting memories for alumni and others over the years.

As the campus has grown outward from the core, design linkages have been incorporated into new buildings and walkways that connect them back to the iconic buildings at the heart of UCLA. A goal of the *Framework* is to extend and reinforce those linkages to create consistency and recognition within other parts of the campus that will harken back to the core.



Royce Hall



Powell Library



Aerial View of Core Campus in 1930s

## IV. Physical Design Standards

### *Building Materials Standards*

The primary materials of new construction typically include UCLA blend brick and buff stone, terracotta, or concrete. These are applied in a variety of idioms, responsive to the function of particular buildings and their particular sites. They are enduring materials that express a quality of permanence and durability.

The most basic element of the materials used on the UCLA campus is brick. A standard size brick, in a unique four color blend, is specified by the campus' Architectural Guidelines. It is manufactured locally by the same company that provided the brick for Royce Hall. The brick on the original buildings has a variety of hues and patterning in keeping with the richness of the Italian Romanesque style. The four color blend that has been developed is an approximation of the colors of the original buildings and has been successfully used on a number of newer buildings such as the Anderson Graduate School of Management. However, some variation of the blend hues, mortar, and bond patterns are appropriate in various new construction projects in order to create scale and continued visual interest.

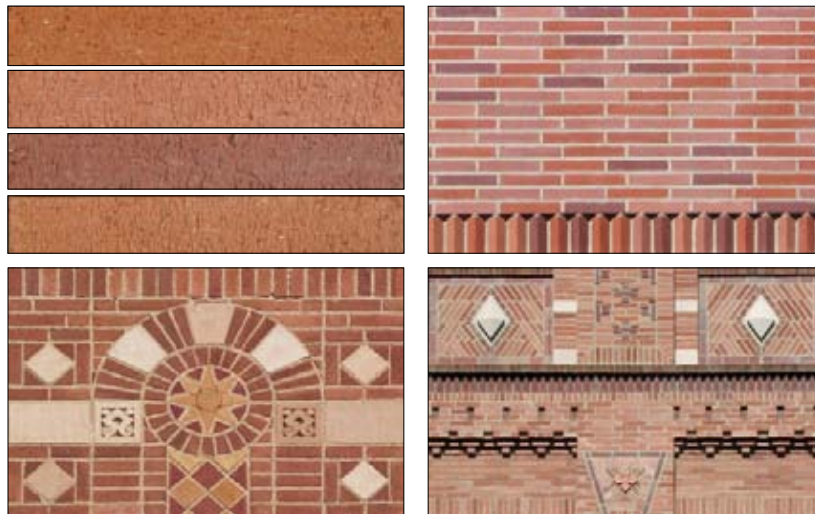

UCLA four color brick blend and historical patterns

The other important materials used on UCLA buildings are a buff or beige colored stone, terracotta, concrete, or plaster. In the original iconographic buildings these materials were incorporated in the form of carved limestone or cast terracotta. A number of more modern materials can be included in proposed projects, as it is the consistency in the coloration that is the most relevant aspect. Thus, beige concrete block, metal panels, and modern cast terracotta have all been incorporated in recent buildings and still meet the campus standards. The brick and the buff colors are often combined or interwoven with each other in a way that further recalls the polychrome nature and human scale of the Italian Romanesque style. In some buildings, this might be in a direct historically referential treatment, while in others it might be more abstract.

Some buildings might utilize limited amounts of brick, but be expressed mostly with beige as a primary color of the materials. Others might be the reverse. These design choices are informed by the more immediate context of the site for the proposed project.

Other materials in buildings such as glass and metals should not be reflective and should typically avoid bright colors. Tile roofs occur on many UCLA buildings, but are not a consistent requirement, as even many of the original buildings had flat roof areas.



Typical buff colored stone, precast concrete, concrete block or terracotta

## IV. Physical Design Standards

### *Pedestrian Circulation and Campus Hardscape*

The large pedestrian population on campus moves through a network of campus walkways composed of brick and buff concrete that creates a unifying ground plane element. Use of the four color UCLA brick blend and a buff colored concrete has been developed as a campus standard for all new paving. The actual patterning of the brick and concrete varies from project to project depending upon the specific context. However, the consistent use of the materials as an integrating device in the ground plane treatment provides significant visual connections to the heart of the campus. As projects are developed, the campus strives to upgrade paved areas to increase the reach of these walkways and improve campus wayfinding.



Campus Hardscape

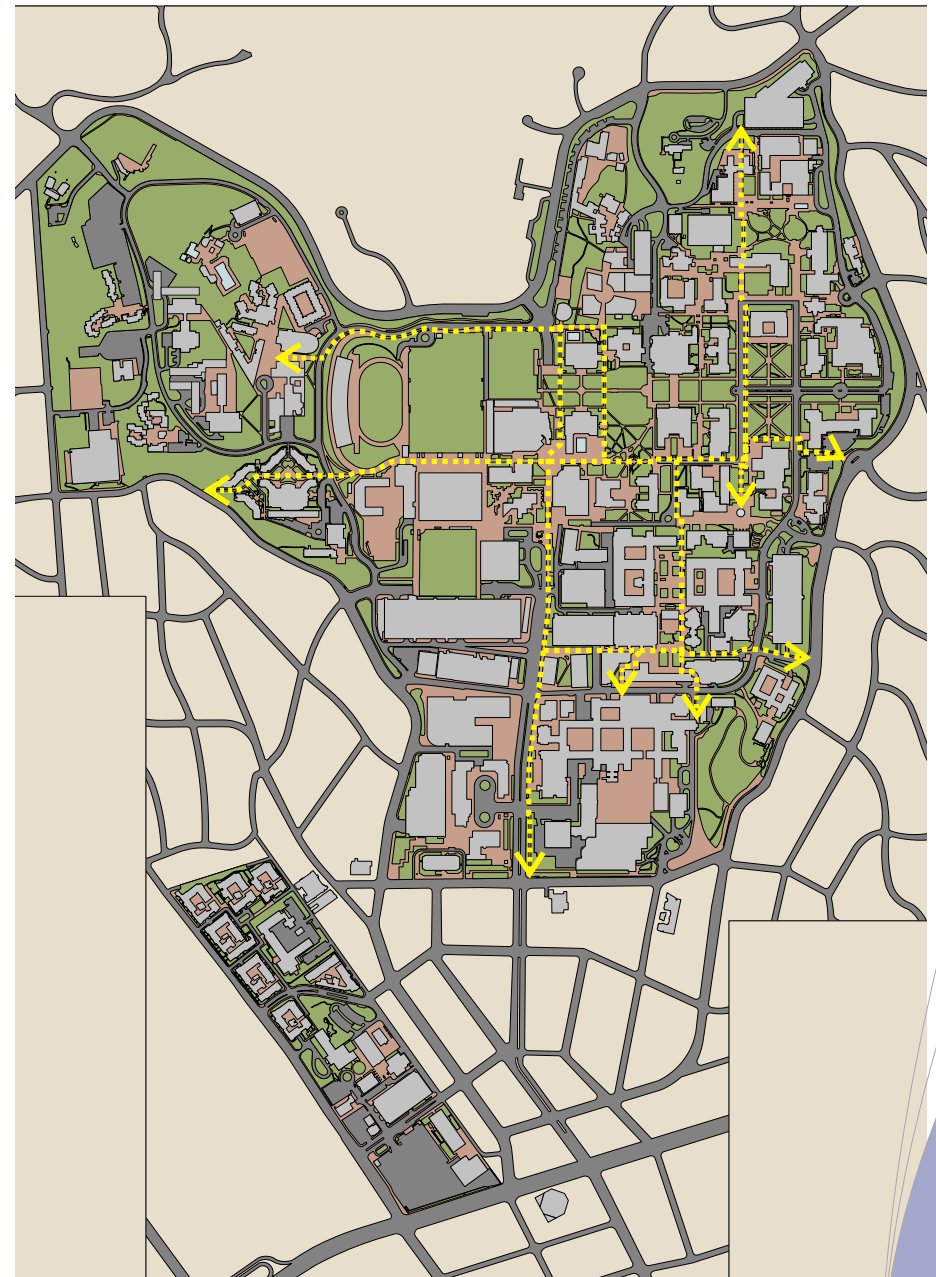

Pedestrian Circulation Diagram

## IV. Physical Design Standards

### *Open Space and Landscape*

UCLA is widely noted for the beauty and diversity of its landscaping that have become the foundation of the campus reputation for a garden-like environment. The campus continues to take advantage of its Mediterranean climate to utilize native and other ornamental plant and tree species suited to specific sites to enrich the natural and aesthetic aspects of the campus environment, while remaining cognizant of the need to utilize water-efficient plantings.

Open space is an essential component of the aesthetic and social life of the campus. Plazas, courts, gardens, walkways, visual corridors, and outdoor eating areas have been developed with as

much attention and vigor as buildings and parking structures. Since the Southern California climate permits year-around use of the outdoors, open spaces are truly permanent “living rooms.”

To ensure that open space and landscaping are incorporated in the site design of all new buildings, each project utilizes the physical planning objectives identified in the LRDP as described previously in this *Framework*. Should mature trees be affected or removed as a result of new development projects, the LRDP EIR has adopted mitigation measures that provide for tree protection and replacement. Appendix A provides the LRDP EIR mitigation measures adopted for provision and protection of landscape and biological resources.



Murphy Sculpture Garden



## IV. Physical Design Standards

### *Campus Furniture & Signage*

Consistency of detail in way-finding signage, building identification, lighting, benches, and other street furniture is essential to reinforcing the campus identity. The Architectural Guidelines denote specific selections for these elements based on successful experience with these items over many years. The incorporation of these small, but significant details in projects is essential to the strength of the overall campus image.

Many of the furniture items are painted a dark brown color known on the campus as “Charles E. Young Brown.” Application

of this color treatment to accessories and signage works well in the landscape and reinforces a sense of unity.

The campus has developed signage guidelines and pays strict attention to the addition of signs on campus. In order to maintain an overall image of institutional dignity, the addition of oversized signs or retail-like designs is prohibited. A special font, UCLA Gothic, is utilized on exterior signs, typically with white letters on a dark brown background. For building names, a brushed muntz metal letter is typically used, though in some cases the letters are actually engraved into architectural elements.



Campus Furniture

Signage

## IV. Physical Design Standards

### *Architectural Implementation*

The various elements of the Architectural Guidelines and campus standards have been combined in numerous ways in projects built over the last twenty years. Use of the guidelines and standards

has resulted in the creation of individual buildings that exhibit an enduring quality, clearly belonging to a family of buildings on the UCLA campus. The buildings shown here are among the most successful additions to the campus and represent aspirations and measures for future design efforts.



Gloria Kaufman Hall



Powell Library South



Neuroscience Research Building (Photograph by Steinkamp-Ballogg Photography)



Anderson Graduate School of Management

## IV. Physical Design Standards

### *Architectural Implementation (Cont'd)*

The buildings on campus express an architectural range from historically referential in appearance to strongly expressive of modern technology; yet they share the connection of material and colors. Buildings located close to the historic core, such as

the Law Library Addition and the Physics & Astronomy Building, tend to emulate the polychrome characteristic, scale, and detail of the Lombardy Romanesque style of the original campus historic structures. The Strathmore Building and Wooden West successfully incorporate the campus materials and color palette in more modern designs.



Wooden West



Strathmore Building



Law Library Addition



Physics & Astronomy Building

## IV. Physical Design Standards

### *Architectural Implementation (Cont'd)*

Other buildings that are located further from the historic core have a modern expression while varying the amount and distribution of brick and buff materials. Despite variance from

the original stylistic approach, these buildings retain a high degree of articulation and relate to a human scale. Often there are large expanses of glazing that are contrasted against areas of masonry walls. Incorporation of sunshade elements on these large glazed expanses reduces heat load and energy consumption.



Morgan Center



Acosta Training Center



Orthopaedic Hospital Research Center



Engineering V

## IV. Physical Design Standards

### *Architectural Implementation (Cont'd)*

The variation in individual buildings provides a balance to the possibility of a relentless sameness that could result from the strict implementation of the standards. This is where the skill of the architects must consider the local campus context of a

particular site to deftly integrate the designs. For example, in the Weyburn Terrace graduate student housing, the architectural forms are referential to the Los Angeles courtyard housing of Westwood Village rather than to the Italian Romanesque style. Similarly, at Broad Art Center and at the Northwest housing residence halls, much of the brick is incorporated in the ground plane or lower portions of the buildings.



Rendering of Police Station (Under Construction)



Weyburn Terrace (Photograph by Arden Photography)



Broad Art Center



Northwest Student Housing - Rieber Vista and Rieber Terrace (Photograph from Michael Moran)

## IV. Physical Design Standards

### Site Character and Context

As noted in the description of the LRDP, campus development opportunities would primarily involve infill, reconstruction, and replacement. The sites chosen for new buildings shall respect and reinforce the strength of the campus context and consistently utilize the broad planning principles outlined in the LRDP. In addition, new projects will be integrated into the campus context by following these strategies:

- Recognize major organizing axes in the campus plan
- Maintain orthogonal orientation as an orienting device
- Respect and reinforce the open space and edges

Although the LRDP identifies eight land use zones on the campus, there is not an intent to have a distinct architectural character for each of these zones. Rather, the physical design guidelines are meant to apply to the entire campus and create unity and continuity across the zones.

The Core Zone and Central Zone both are both part of the original master plan area of the campus. New development here needs to respect and reinforce the original formal planning concepts and strongly adhere to the campus materials palette.

The Northwest Zone is characterized by a mix of primarily undergraduate housing, recreation, and open space. New projects in this zone should utilize the UCLA blend brick in the pedestrian accessible areas including the base of buildings, urban plazas, and other ground plane treatment. The buildings should primarily incorporate buff color tones with some variety of earth tones to accent or highlight building entrances or special function areas.

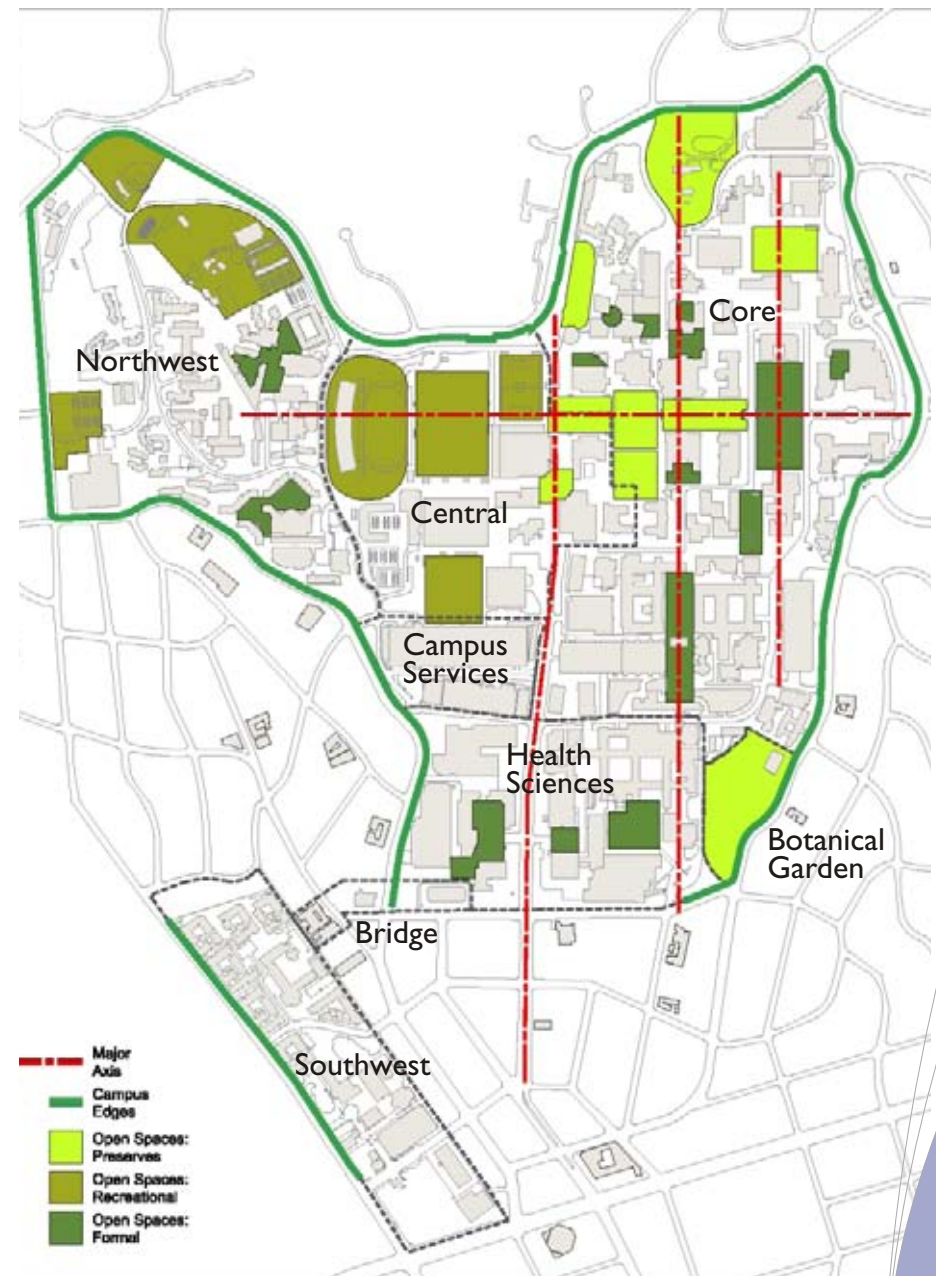

## IV. Physical Design Standards

### *Site Character and Context (Cont'd)*

The Health Sciences Zone represents the area of highest density on the southern portion of the main campus. The area is currently comprised of some varied architectural parts:

- The Center for Health Sciences (CHS) Complex
- Ronald Reagan Medical Center
- Medical Plaza
- Stein Plaza

Though the original master plan for the campus did not contemplate a large medical enterprise, the rapid growth of the CHS has resulted in buildings with distinct architectural styles. Therefore, new projects in this densely developed area should strive to weave the disparate styles together to the extent possible. This should be done by integrating the campus materials palette and enhancing the UCLA identity along Westwood Plaza. Renovation and reconstruction efforts, particularly in the CHS Complex, should strive to increase connectivity, porosity, and orientation within and on the edges of the zone.

The Southwest Zone was also not part of the original master plan and is separated from the main campus by Westwood Village. The zone is essentially comprised of three different sections. The northern section is primarily occupied by the Weyburn Terrace graduate student housing that links strongly to Westwood Village and the traditions of Mediterranean courtyard housing of Los Angeles. Future buildings in this area should be similar to this architectural treatment and should be white and tan stucco with tile roofs. The middle section of the Southwest Zone contains existing buildings of varying architectural styles and mixed uses. The Science and Technology Research Building (STRB) utilizes the campus materials and is organized with an arcade facing an internal open space. New development in the zone would likely utilize STRB as a model. The southern section of this zone (Parking Lot 36) represents a site with potential for a

large scale development on the high-rise Wilshire Boulevard corridor. Application of the planning guidelines and physical design aspects to this site would likewise reflect a high density use with subterranean parking to replace the existing surface parking. Representing an important land resource on the campus, this site's future development will be considered in conjunction with regional transportation plans for a potential subway station that could be transformative to this portion of the campus and the Westwood area.



CHS South Tower

## IV. Physical Design Standards

### *Integrated Larger Scale Imagery*

The effort to create an enduring quality for the UCLA campus and a powerful sense of place requires a consistent application of materials and attention to details. This is reflected by distant views of the campus that have been enhanced over time into an integrated whole where the sum effect is greater than that of the individual parts.



Integrated Design Imagery



## V. Design Process and Review

All new capital improvement projects are formally reviewed and approved by various campus entities and stakeholders during the project development process. The key milestones consist of project (budget) approval and design approval, which is aligned with the typical process for Regents approval of major projects.

### *Pre-Design and Project Approval*

At the inception of a project, Capital Planning is responsible for project development. This involves analyzing the various components of the proposed site, program aspirations, and project goals. Determination of a project scope, justification and need, description, concept budget, and schedule are all components developed early in the design process and are included in a draft Project Planning Guide (PPG). The PPG incorporates a comprehensive articulation of the project including cost and schedule and is the guiding document used to obtain formal campus approval for incorporation of the project into the Campus' Capital Improvement Program. Concurrently, a pre-design phase begins with a project design consultant/architect who may eventually be responsible for the design. In this phase, a more definitive schedule and budget are established for the project based upon detailed analysis of the site conditions, potential architectural solutions, environmental issues, sustainability goals, and program development. The initial pre-design work is reviewed by the project proponent and Capital Programs staff in an iterative and interactive fashion and brought to the Capital Programs Project Development Committee for input. The proposed project is then reviewed by the Campus Space Committee that is comprised of campus executive management. Project proposals are typically presented at this early stage of the design process at regularly scheduled Community Leaders Meetings to engage the off campus constituents.

### *Design and Environmental Approval*

The design of a project typically consists of three phases,

Schematic Design, Design Development, and Construction Documents. The primary design direction of a project is set in Schematic Design and includes the site layout, massing, scale, character, and materials. All three phases of a project are reviewed in detail by Capital Programs staff and the Campus Architect to ensure consistency with the physical design standards and Architectural Guidelines. Along with the regular reviews by the campus project proponents, the design is periodically brought to the Capital Programs Project Development Committee. Throughout this process, Capital Planning remains involved to conduct the environmental review process in accordance with the California Environmental Quality Act (CEQA) and ensure the project is consistent with the PPG and incorporates the appropriate LRDP provisions and LRDP EIR adopted mitigation measures.



Bruin Bear

## VI. Appendices

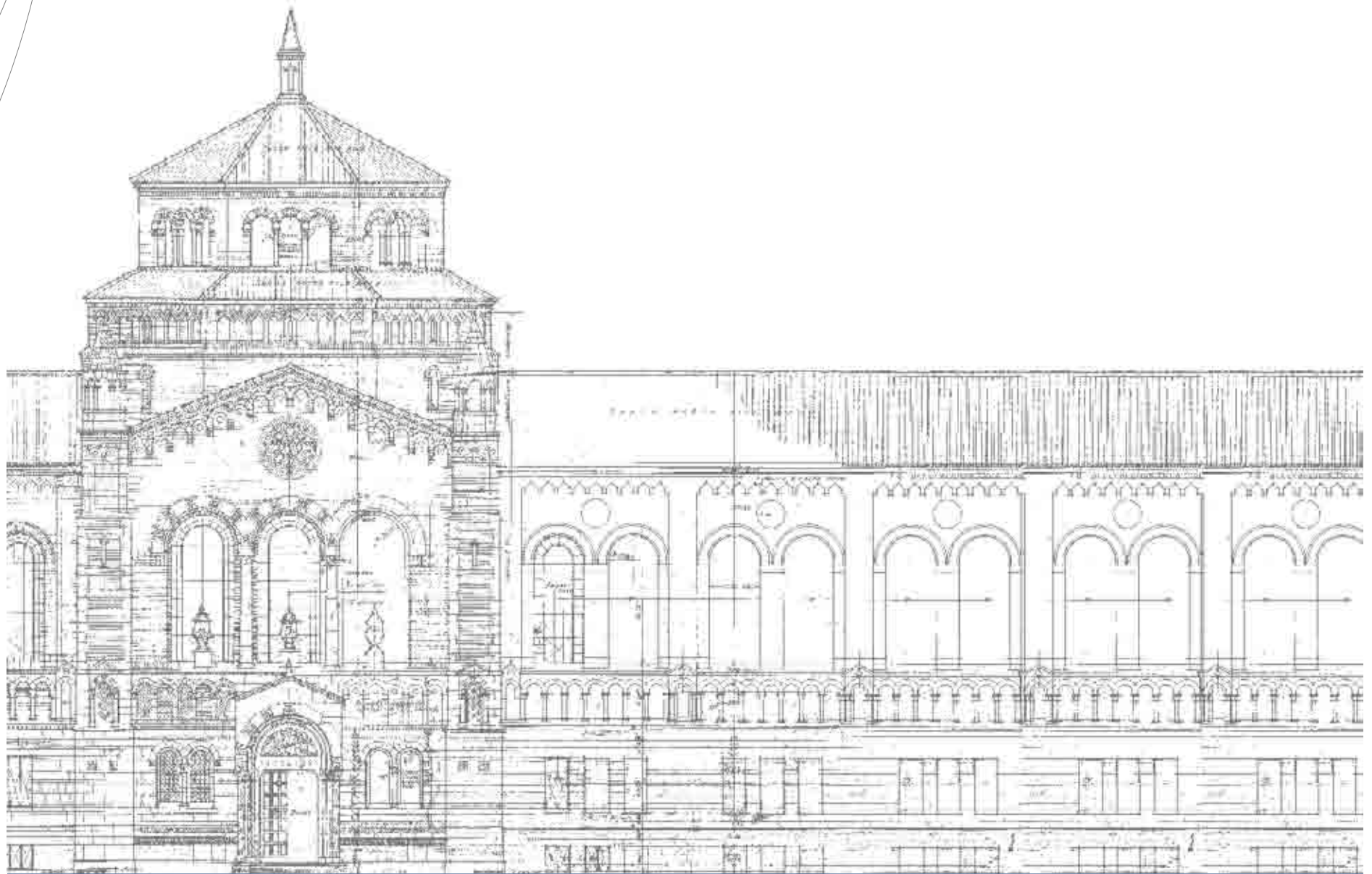

## VI. Appendix A. LRDP EIR Mitigation Monitoring Program

### MITIGATION MEASURES OR APPLICABLE CAMPUS PROGRAMS, PRACTICES AND PROCEDURES INCORPORATED INTO CAMPUS PROJECTS

MM and PP Number	Mitigation Timing	Mitigation Measure(s) (MMs) or Applicable Campus Programs, Practices, and Procedures (PPs)
<b>Aesthetics</b>		
PP 4.1-1(a)	Design	The design process shall evaluate and incorporate, where appropriate, factors including, but not necessarily limited to, building mass and form, building proportion, roof profile, architectural detail and fenestration, the texture, color, and quality of building materials, focal views, pedestrian and vehicular circulation and access, and the landscape setting to ensure preservation and enhancement of the visual character and quality of the campus and the surrounding area. Landscaped open space (including plazas, courts, gardens, walkways, and recreational areas) shall be integrated with development to encourage use through placement and design.
PP 4.1-1(b)	Design	The Mildred E. Mathias Botanical Garden, Franklin D. Murphy Sculpture Garden, Dickson Plaza, Janss Steps, Stone Canyon Creek area, Meyerhoff Park, Wilson Plaza, Bruin Plaza, and the University Residence shall be maintained as open space preserves during the 2002 LRDP planning horizon.
PP 4.1-2(a)	Design	Additions to, or expansions of, existing structures shall be designed to complement the existing architectural character of the buildings.
PP 4.1-2(b)	Design	The architectural and landscape traditions that give the campus its unique character shall be respected and reinforced.
PP 4.1-2(c)	Design and Construction	Projects proposed under 2002 LRDP shall include landscaping.
PP 4.1-2(d)	Design	The western, northern, and eastern edges of the main campus shall include a landscaped buffer to complement the residential uses of the surrounding community and to provide an attractive perimeter that effectively screens and enhances future development.
MM 4.1-3(a)	Design	Design for specific projects shall provide for the use of textured non-reflective exterior surfaces and non-reflective glass.
MM 4.1-3(b)	Design	All outdoor lighting shall be directed to the specific location intended for illumination (e.g., roads, walkways, or recreation fields) to limit stray light spillover onto adjacent residential areas. In addition, all lighting shall be shielded to minimize the production of glare and light spill onto adjacent uses.
MM 4.1-3(c)	Design	Ingress and egress from parking areas shall be designed and situated so the vehicle headlights are shielded from adjacent uses. If necessary, walls or other light barriers will be provided.
<b>Air Quality</b>		
PP 4.2-2(a)	Construction	<p>The campus shall continue to implement dust control measures consistent with SCAQMD Rule 403—Fugitive Dust during the construction phases of new project development. The following actions are currently recommended to implement Rule 403 and have been quantified in the URBEMIS program as being able to reduce dust generation between 5 and 84 percent depending on the measure or combination of measures used from the list below:</p> <ul style="list-style-type: none"> <li><input type="checkbox"/> Minimize land disturbance to the extent feasible.</li> <li><input type="checkbox"/> Apply water and/or approved nontoxic chemical soil stabilizers according to manufacturer's specification to all inactive construction areas (previously graded areas that have been inactive for 10 or more days)</li> <li><input type="checkbox"/> Apply water three times daily to all active disturbed areas.</li> <li><input type="checkbox"/> Replace ground cover in disturbed areas as quickly as possible.</li> <li><input type="checkbox"/> Enclose, cover, water twice daily, or apply approved chemical soil binders to exposed piles with 5 percent or greater silt content.</li> <li><input type="checkbox"/> Water active grading sites at least twice daily.</li> </ul>

## VI. Appendix A. LRDP EIR Mitigation Monitoring Program

MM and PP Number	Mitigation Timing	Mitigation Measure(s) (MMs) or Applicable Campus Programs, Practices, and Procedures (PPs)
		<ul style="list-style-type: none"> <li><input type="checkbox"/> Suspend all excavating and grading operations when wind speeds (as instantaneous gusts) exceed 25 miles per hour over a 30-minute period.</li> <li><input type="checkbox"/> All trucks hauling dirt, sand, soil, or other loose materials are to be covered or should maintain at least two feet of freeboard (i.e., minimum vertical distance between top of the load and the top of the trailer), in accordance with Section 23114 of the California Vehicle Code.</li> <li><input type="checkbox"/> Sweep streets at the end of the day if visible soil material is carried over to adjacent roads.</li> <li><input type="checkbox"/> Install wheel washers where vehicles enter and exit unpaved roads onto paved roads, or wash off trucks and any equipment leaving the site each trip.</li> <li><input type="checkbox"/> Apply water three times daily or chemical soil stabilizers according to manufacturers' specifications to all unpaved parking or staging areas or unpaved road surfaces.</li> <li><input type="checkbox"/> Post and enforce traffic speed limits of 15 miles per hour or less on all unpaved roads.</li> </ul>
PP 4.2-2(b)	Pre-construction and Construction	The campus shall continue to require by contract specifications that construction equipment engines will be maintained in good condition and in proper tune per manufacturer's specification for the duration of construction.
PP 4.2-2(c)	Pre-construction and Construction	The campus shall continue to require by contract specifications that construction operations rely on the campus's existing electricity infrastructure rather than electrical generators powered by internal combustion engines to the extent feasible.
PP 4.2-2(d)	Construction	The campus shall purchase and apply architectural coatings in accordance with SCAQMD Rule 1113, thereby ensuring the limitation of VOCs during construction.
MM 4.2-2(a)	Pre-construction and Construction	The campus shall require by contract specifications that construction-related equipment, including heavy-duty equipment, motor vehicles, and portable equipment, shall be turned off when not in use for more than five minutes.
MM 4.2-2(b)	Pre-construction and Construction	The campus shall encourage contractors to utilize alternative fuel construction equipment (i.e., compressed natural gas, liquid petroleum gas, and low-NO <sub>x</sub> fuel) to the extent that the equipment is reasonably commercially available and cost effective.
MM 4.2-2(c)	Pre-construction and Construction	The campus shall require by contract specifications that construction-related equipment used on site and for on-road transport of soil meet USEPA Tier III certification requirements, as feasible.
<b>Biological Resources</b>		
PP 4.3-1(a)	Construction	Mature trees to be retained and protected in place during construction, shall be fenced at the drip-line, and maintained by the contractor in accordance with landscape specifications contained in the construction contract.
PP 4.3-1(b)	Pre-construction	Trees shall be examined by an arborist and trimmed, if appropriate, prior to the start of construction.
PP 4.3-1(c)	Pre-construction and Construction	Construction contract specifications shall include the provision for temporary irrigation/watering and feeding of these trees during construction, as recommended by the designated arborist.
PP 4.3-1(d)	Pre-construction and Construction	Construction contract specifications shall require that no building material, parked equipment, or vehicles shall be stored within the fence line of any tree.
PP 4.3-1(e)	Construction	Examination of these trees by an arborist shall be performed monthly during construction to ensure that they are being adequately maintained.
MM 4.3-1(a)	Pre-construction	Prior to the onset of construction activities that occur between March and mid-August (February 1 through June 30 for raptors), surveys for nesting special status avian species and raptors shall be conducted on the affected portion of the campus following USFWS and/or CDFG guidelines. If no active avian nests are identified on or within 250 feet of the construction site, no further mitigation is necessary.
MM 4.3-1(b)	Pre-construction	If active nests for avian species of concern or raptor nests are found within the construction footprint or within a 250-foot buffer zone around the construction site, exterior construction activities shall be delayed within the construction footprint and buffer zone

## VI. Appendix A. LRDP EIR Mitigation Monitoring Program

MM and PP Number	Mitigation Timing	Mitigation Measure(s) (MMs) or Applicable Campus Programs, Practices, and Procedures (PPs)
		until the young have fledged or appropriate mitigation measures responding to the specific situation have been developed and implemented in consultation with CDFG.
MM 4.3-1(c)	Design and Construction	In conjunction with CEQA documentation required for each project proposal under the 2002 LRDP, as amended, that would result in the removal of one or more mature trees, the project will include a tree replacement plan with a 1:1 tree replacement ratio at the development site where feasible and/or elsewhere within the campus boundaries where feasible. If it is not feasible to plant replacement trees at a 1:1 ratio within the campus boundaries, the tree replacement plan will include the planting of native shrubs in ecologically appropriate areas within the campus boundaries that would provide nesting, foraging or roosting habitat for birds so that the replacement number of trees and shrubs will result in a 1:1 replacement ratio.
MM 4.3-2(a)	CEQA Documentation  Not applicable to 2008 NHIP	In conjunction with CEQA documentation required for any future project proposal within the 4-acre parcel or the aboveground portion of Stone Canyon Creek, surveys for special status plant species shall be conducted during the appropriate blooming period for each species, as determined by reference populations, to determine the presence or absence of these species. If no special status plant species are identified within the impact area, no further mitigation are necessary and the results of the survey shall be included in the CEQA documentation
MM 4.3-2(b)	CEQA Documentation and Pre-construction  Not applicable to 2008 NHIP	<p>If special status plant species are observed during focused surveys and if the status of the species and the size of the population warrant a finding of significance pursuant to CEQA, then appropriate mitigation measures shall be developed and included in the project-specific CEQA documentation. A detailed Mitigation Plan shall be prepared and approved prior to grading and may include, but not be limited to, one or more of the following actions:</p> <ul style="list-style-type: none"> <li><input type="checkbox"/> Avoiding impacts to the species to the extent possible through project planning;</li> <li><input type="checkbox"/> Minimizing impacts to the species to the extent possible through project planning;</li> <li><input type="checkbox"/> Rectifying the impact by repairing, rehabilitating, or restoring the impacted environment;</li> <li><input type="checkbox"/> Reducing or eliminating the impact over time by preservation and maintenance operations during the life of the project;</li> <li><input type="checkbox"/> Compensating for the impact by replacing or providing substitute resources or environments.</li> </ul> <p>As appropriate, the Mitigation Plan may include, but not be limited to:</p> <ul style="list-style-type: none"> <li><input type="checkbox"/> Details for a salvage program;</li> <li><input type="checkbox"/> Replacement ratios;</li> <li><input type="checkbox"/> Performance criteria for the relocated population;</li> <li><input type="checkbox"/> Site-selection parameters to ensure there are no secondary impacts from mitigation;</li> <li><input type="checkbox"/> Program implementation methods within one year of grading;</li> <li><input type="checkbox"/> Methods to maintain the site for 5 years;</li> <li><input type="checkbox"/> Long-term preservation in dedicated open space.</li> </ul>
MM 4.3-2(c)	CEQA Documentation  Not applicable to 2008 NHIP	In conjunction with CEQA documentation required for any future project proposal within the 4-acre parcel, focused surveys for the coastal California gnatcatcher and other special status wildlife species that could occur in coastal sage scrub shall be conducted. Surveys shall follow the USFWS protocol to determine the presence or absence of this species. If no coastal California gnatcatchers are identified in the impact area, no further mitigation are necessary and the results of the survey shall be included in the CEQA documentation.
MM 4.3-2(d)	CEQA Documentation  Not applicable to	In conjunction with CEQA documentation required for any future project proposal within the 4-acre parcel, a Coastal Sage Scrub Mitigation Plan shall be prepared and approved by the USFWS prior to grading. In addition, grading of coastal sage scrub shall not occur during the coastal California gnatcatcher nesting season (February 15 to August 15). The Mitigation Plan may include, but not be limited to, one or more of the following actions:

## VI. Appendix A. LRDP EIR Mitigation Monitoring Program

MM and PP Number	Mitigation Timing	Mitigation Measure(s) (MMs) or Applicable Campus Programs, Practices, and Procedures (PPs)
	2008 NHIP	<ul style="list-style-type: none"> <li><input type="checkbox"/> Avoiding impacts to coastal sage scrub to the extent possible through project planning;</li> <li><input type="checkbox"/> Minimizing impacts to coastal sage scrub to the extent possible through project planning;</li> <li><input type="checkbox"/> Rectifying the impact by repairing, rehabilitating, or restoring the impacted environment;</li> <li><input type="checkbox"/> Reducing or eliminating the impact over time by preservation and maintenance operations during the life of the project;</li> <li><input type="checkbox"/> Compensating for the impact by replacing or providing substitute resources or environments.</li> </ul> <p>As appropriate, the Mitigation Plan may include, but not be limited to:</p> <ul style="list-style-type: none"> <li><input type="checkbox"/> Replacement ratios;</li> <li><input type="checkbox"/> Performance criteria;</li> <li><input type="checkbox"/> Site-selection parameters to ensure there are no secondary impacts from mitigation;</li> <li><input type="checkbox"/> Program implementation methods within one year of grading;</li> <li><input type="checkbox"/> Methods to maintain the site for 5 years;</li> <li><input type="checkbox"/> Long-term preservation in open space.</li> </ul>
MM 4.3-2(e)	CEQA Documentation  Not applicable to 2008 NHIP	If coastal California gnatcatcher or other special status species is observed within or immediately adjacent to the impact footprint during focused surveys, construction will not proceed until authorization is granted by the U.S. Fish and Wildlife Service via a Section 7 Permit or a 10a Permit. All conditions of such permits will be complied with in order to avoid or minimize impacts on the coastal California gnatcatcher.
MM 4.3-4	Construction	UCLA shall replace protected trees removed for construction of projects under the 2002 LRDP, as amended, with protected trees of the same species at a 2:1 ratio as presented in the City of Los Angeles Protected Tree Ordinance (Ordinance Number 177404). Protected trees are defined as coast live oak, valley oak, western sycamore, Southern California black walnut, and California bay laurel.
MM 4.3-5(a)	CEQA Documentation  Not applicable to 2008 NHIP	In conjunction with CEQA documentation required for any future project proposal in proximity to Stone Canyon Creek, a jurisdictional delineation shall be conducted to describe and map the extent of resources under the jurisdiction of the USACE and/or the CDFG following the guidelines presented in the <i>Interim Regional Supplement to the Corps of Engineers Wetland Delineation Manual: Arid West Region</i> (USACE 2006). The results of the delineation shall be included in the CEQA documentation.
MM 4.3-5(b)	Pre-construction  Not applicable to 2008 NHIP	Prior to any direct or indirect impacts to jurisdictional areas within Stone Canyon Creek, permits/agreements from the USACE, the RWQCB, and/or the CDFG shall be required. Acquisition and implementation of the permit/agreement may constrain proposed activities; impacts on jurisdictional resources should be minimized to the extent practicable. Mitigation for impacts on jurisdictional resources may include avoidance or minimization of impacts, compensation in the form of habitat restoration, or compensation through participation in a mitigation bank. The exact requirements of any special permit conditions established for impacts on the creek would be determined by the USACE (Section 404) and/or the CDFG (Streambed Alteration Agreement) following review of the formally submitted project application after completion of the CEQA process.
<b>Cultural Resources</b>		
PP 4.4-1(a)	CEQA Documentation and Design	Structures outside the campus Historic Core that appear to have historic significance, or are over 45 years old, that may be directly or indirectly impacted by a proposed development project shall be reviewed by the campus and a qualified architectural historian or historic architect for eligibility for listing on the California Register of Historical Resources. If a structure is identified as eligible for listing in the California Register of Historical Resources, and it is determined that the project could have a significant adverse impact on the structure, the campus and a qualified historic architect shall consider design modifications, mitigation measures

## VI. Appendix A. LRDP EIR Mitigation Monitoring Program

MM and PP Number	Mitigation Timing	Mitigation Measure(s) (MMs) or Applicable Campus Programs, Practices, and Procedures (PPs)
		and/or alternatives that could minimize, avoid or substantially reduce the impacts, and consider whether and to what extent the project could comply with the <i>Secretary of the Interior's Standards for the Treatment of Historic Properties with Guidelines for Preserving, Rehabilitating, Restoring, and Reconstructing Historic Buildings</i> (Weeks and Grimmer 1995).
PP 4.4-1(b)	CEQA Documentation and Design  Not applicable to 2008 NHIP	The integrity of the Campus Historic Core shall be maintained. Structures over 45 years old within the Campus Historic Core that have not yet been evaluated for potential historic significance and may be directly or indirectly impacted by a proposed development project shall be reviewed by the campus and a qualified architectural historian or historic architect for eligibility for listing in the California Register of Historical Resources. The campus shall continue to implement all modifications to historic structures within the Historic Core in compliance with the <i>Secretary of the Interior's Standards for Treatment of Historic Properties with Guidelines for Preserving, Rehabilitating, Restoring, and Reconstructing Historic Buildings</i> (Weeks and Grimmer 1995).
MM 4.4-2(a)	Pre-construction	Prior to site preparation or grading activities, construction personnel shall be informed of the potential for encountering unique archaeological resources and taught how to identify these resources if encountered. This shall include the provision of written materials to familiarize personnel with the range of resources that might be expected, the type of activities that may result in impacts, and the legal framework of cultural resources protection. All construction personnel shall be instructed to stop work in the vicinity of a potential discovery until a qualified, non-University archaeologist assesses the significance of the find and implements appropriate measures to protect or scientifically remove the find. Construction personnel shall also be informed that unauthorized collection of archaeological resources is prohibited.
MM 4.4-2(b)	Construction	Should archaeological resources be found during ground-disturbing activities for any project, a qualified Archaeologist shall first determine whether an archaeological resource uncovered during construction is a "unique archaeological resource" pursuant to Section 21083.2(g) of the Public Resources Code or a "historical resource" pursuant to Section 15064.5(a) of the CEQA Guidelines. If the archaeological resource is determined to be a "unique archaeological resource" or a "historical resource," the Archaeologist shall formulate a mitigation plan in consultation with the campus that satisfies the requirements of Section 21083.2 and 15064.5.  If the Archaeologist determines that the archaeological resource is not a "unique archaeological resource" or "historical resource," s/he may record the site and submit the recordation form to the California Historic Resources Information System at the South Central Coastal Information Center.  The Archaeologist shall prepare a report of the results of any study prepared as part of a mitigation plan, following accepted professional practice. Copies of the report shall be submitted to the University and to the California Historic Resources Information System at the South Central Coastal Information Center.
MM 4.4-2(c)	Pre-construction  Not applicable to 2008 NHIP	Prior to initiation of construction activities for projects that require disturbance of native sediments/soils (as identified through site-specific geotechnical analysis), the campus shall retain a qualified non-University Archaeologist to observe grading activities and recover, catalogue, analyze, and report archaeological resources as necessary. The qualified Archaeologist shall submit to the Capital Programs University Representative, a written plan with procedures for archaeological resource monitoring. This plan shall include procedures for temporarily halting or redirecting work to permit the sampling, identification, and evaluation of the resources as appropriate.

## VI. Appendix A. LRDP EIR Mitigation Monitoring Program

MM and PP Number	Mitigation Timing	Mitigation Measure(s) (MMs) or Applicable Campus Programs, Practices, and Procedures (PPs)
MM 4.4-3(a)	Pre-construction  For 2008 NHIP only applicable to the Upper and Lower De Neve Buildings	Prior to site preparation or grading activities, construction personnel shall be informed of the potential for encountering paleontological resources and taught how to identify these resources if encountered. This shall include the provision of written materials to familiarize personnel with the range of resources that might be expected; the type of activities that may result in impacts; and the legal framework of cultural resources protection. All construction personnel shall be instructed to stop work in the vicinity of a potential discovery until a qualified, non-University Paleontologist assesses the significance of the find and implements appropriate measures to protect or scientifically remove the find. Construction personnel shall also be informed that unauthorized collection of paleontological resources is prohibited.
MM 4.4-3(b)	Construction	A qualified Paleontologist shall first determine whether a paleontological resource uncovered during construction meets the definition of a "unique archaeological resource" under Public Resources Code, Section 21083.2(g) or a "historical resource" under Section 15064.5 of the CEQA Guidelines. If the paleontological resource is determined to be a "unique archaeological resource" or a "historical resource", the Paleontologist shall formulate a Mitigation Plan in consultation with the campus that satisfies the requirements of Section 21083.2 of the CEQA Statutes.  If the Paleontologist determines that the paleontological resource is not a unique resource, s/he may record the site and submit the recordation form to the Natural History Museum of Los Angeles County.  The Paleontologist shall prepare a report of the results of any study prepared as part of a mitigation plan, following accepted professional practice. Copies of the report shall be submitted to the University and to the Natural History Museum of Los Angeles County.
<b>Geology and Soils</b>		
PP 4.5-1(a)	Design	During project-specific building design, a site-specific geotechnical study shall be conducted under the direct supervision of a California Registered Engineering Geologist or licensed Geotechnical Engineer to assess detailed seismic, geological, soil, and groundwater conditions at each construction site and develop recommendations to prevent or abate any identified hazards in accordance with the requirements of the California Building Code applicable at the time of construction. Recommendations from the site-specific geotechnical study shall be included in the grading plans and/or building design specifications for each project. The study shall follow applicable recommendations of CGS Special Publication 117 and shall include, but not necessarily be limited to: <ul style="list-style-type: none"> <li><input type="checkbox"/> Determination of the locations of any suspected fault traces and anticipated ground acceleration at the building site;</li> <li><input type="checkbox"/> Potential for displacement caused by seismically induced shaking, fault/ground surface rupture, liquefaction, differential soil settlement, expansive and compressible soils, landsliding, or other earth movements or soil constraints;</li> <li><input type="checkbox"/> Evaluation of depth to groundwater.</li> </ul>
PP 4.5-1(b)	Operation	The campus shall continue to implement its current seismic upgrade program.
PP 4.5-1(c)	Design and Operation	The campus shall continue to comply with the University Policy on Seismic Safety adopted on January 17, 1995 or with any subsequent revision to the policy that provides an equivalent or higher level of protection with respect to seismic hazards.
PP 4.5-1(d)	Design	Development projects under the LRDP Amendment shall continue to be subject to structural peer review; following this review, any site-specific geotechnical study recommendations, including any recommendations added as a result of the peer review, shall be incorporated in the project design, as appropriate.
MM 4.5-1	Pre-construction  Applicable only to the 2008 NHIP	Prior to approval of final building designs for the 2008 Northwest Housing Infill Project, a qualified Engineer shall review the final designs to verify that all geotechnical recommendations provided in the Geotechnical Engineering Investigation, Proposed UCLA Northwest Student Housing Infill Project (dated May 8, 2008 and prepared by Geotechnologies, Inc.) have been fully and appropriately incorporated. These recommendations shall include, but not be limited to, the following areas of concern: <ul style="list-style-type: none"> <li><input type="checkbox"/> Grading Guidelines (removal of unsuitable soils, hillside grading, compaction).</li> </ul>



## VI. Appendix A. LRDP EIR Mitigation Monitoring Program

MM and PP Number	Mitigation Timing	Mitigation Measure(s) (MMs) or Applicable Campus Programs, Practices, and Procedures (PPs)
		<ul style="list-style-type: none"> <li><input type="checkbox"/> Temporary Excavations (shoring, soldier piles and lagging, anchors, monitoring).</li> <li><input type="checkbox"/> Seismic Design Considerations (2007 California Building Code Seismic Parameters).</li> <li><input type="checkbox"/> Foundation Design (reinforcement, settlement, friction piles, retaining wall setbacks).</li> <li><input type="checkbox"/> Retaining Wall Design (cantilever and restrained walls, waterproofing, drainage, backfill).</li> <li><input type="checkbox"/> Slabs on Grade (concrete, waterproofing, reinforcement).</li> <li><input type="checkbox"/> Pavements (moisture, thickness, weight management).</li> <li><input type="checkbox"/> Site Drainage.</li> <li><input type="checkbox"/> Construction Monitoring and Geotechnical Testing (geotechnical observation and laboratory testing of soils).</li> </ul>
<b>Hazards and Hazardous Materials</b>		
PP 4.6-1	Operation	The campus shall continue to implement the same (or equivalent) health and safety plans, programs, practices, and procedures related to the use, storage, disposal, or transportation of hazardous materials during the LRDP Amendment planning horizon, including, but not necessarily limited to, the Business Plan, Hazardous Materials Management Program, Hazard Communication Program, Injury and Illness Prevention Program, Chemical Exposure Monitoring Program, Asbestos Management Program, Respiratory Protection Program, EH&S procedures for decommissioning and demolishing buildings that may contain hazardous materials, and the Broadscope Radioactive Materials License. These programs may be subject to modification as more stringent standards are developed or if the programs become obsolete through replacement by other programs that incorporate similar health and safety protection measures.
PP 4.6-4	Construction	While not expected to occur on-campus, if contaminated soil and/or groundwater is encountered during the removal of on-site debris or during excavation and/or grading activities, the construction contractor(s) shall stop work and immediately inform the EH&S. An on-site assessment shall be conducted to determine if the discovered materials pose a significant risk to the public or construction workers. If the materials are determined to pose such a risk, a remediation plan shall be prepared and submitted to the EH&S to comply with all federal and State regulations necessary to clean and/or remove the contaminated soil and/or groundwater. Soil remediation methods could include, but are not necessarily limited to, excavation and on-site treatment, excavation and off-site treatment or disposal, and/or treatment without excavation. Remediation alternatives for cleanup of contaminated groundwater could include, but are not necessarily limited to, on-site treatment, extraction and off-site treatment, and/or disposal. The construction schedule shall be modified or delayed to ensure that construction will not inhibit remediation activities and will not expose the public or construction workers to significant risks associated with hazardous conditions.
<b>Hydrology and Water Quality</b>		
PP 4.7-1	Construction and Operation	Construction and operation of projects on campus shall comply with requirements and water quality standards set forth within current NPDES Permit regulations (Phase I and Phase II) at the time of project approval. Pursuant to Phase I permit requirements, UCLA shall develop a Storm Water Pollution Prevention Plan (SWPPP) that incorporates Best Management Practices (BMPs) for reducing or eliminating construction-related and post-construction pollutants in site runoff.
PP 4.7-5	Design	Site-specific hydrologic evaluation shall be conducted for each proposed development project based on the project-specific grading plan and site design of each individual project. This evaluation shall include, but not be limited to: (1) an assessment of runoff quality, volume and flow rate from the proposed project site; (2) identification of project-specific BMPs (structural and non-structural) to reduce the runoff rate and volume to appropriate levels; and (3) identification of the need for new or upgraded storm drain infrastructure (on and off campus) to serve the project. Project design shall include measures to upgrade and expand campus storm drain capacity where necessary, as identified through the project-specific hydrologic evaluation. Design of future projects shall include measures to reduce runoff, including, but not limited to, the provision of permeable landscaped areas adjacent to structures to absorb runoff and the use of pervious or semi-pervious paving materials.
MM 4.7-1	Pre-Construction	Best Management Practices (BMPs) shall be implemented for individual development projects, to the extent required by State law,

## VI. Appendix A. LRDP EIR Mitigation Monitoring Program

MM and PP Number	Mitigation Timing	Mitigation Measure(s) (MMs) or Applicable Campus Programs, Practices, and Procedures (PPs)
	and Construction	<p>to ensure compliance is maintained with all applicable NPDES requirements at the time of project construction. UCLA shall utilize BMPs as appropriate and feasible to comply with and/or exceed the current requirements under the NPDES program. BMPs that may be implemented include, but are not limited to, the following:</p> <p>Non-Structural/Structural</p> <ul style="list-style-type: none"> <li><input type="checkbox"/> Landscape Maintenance</li> <li><input type="checkbox"/> Catch Basin Stenciling and Clean-out</li> <li><input type="checkbox"/> Efficient Irrigation Practices</li> <li><input type="checkbox"/> Litter Control</li> <li><input type="checkbox"/> Fertilizer Management</li> <li><input type="checkbox"/> Public Education</li> <li><input type="checkbox"/> Efficient Irrigation</li> <li><input type="checkbox"/> Permanent Vegetative Controls</li> <li><input type="checkbox"/> Runoff <input type="checkbox"/> Minimizing Landscape Design</li> </ul> <p>Treatment Control BMPs (to minimize storm water pollutants of concern for Ballona Creek - Sediment, Bacteria/Viruses, Toxicity, Trash, and Metals):</p> <ul style="list-style-type: none"> <li><input type="checkbox"/> Vegetated Swale(s) <input type="checkbox"/> An open, shallow channel with vegetation covering side slopes and the bottom.</li> <li><input type="checkbox"/> Bioretention <input type="checkbox"/> A basin that functions as a soil and plant-based filtration device that removes pollutants through a variety of physical, biological, and chemical treatment processes.</li> <li><input type="checkbox"/> Turf Block <input type="checkbox"/> A grass area that has a structural component which allows it to be used in drive aisles and parking lots.</li> <li><input type="checkbox"/> Drain Inserts <input type="checkbox"/> A manufactured filter placed in a drop inlet to remove sediment and debris.</li> </ul>
<b>Land Use and Planning</b>		
PP 4.8-1(a)	Design  Not applicable to 2008 NHIP	Development of the southern edge of the main campus shall be designed to enhance the campus interface with Westwood Village.
PP 4.8-1(b)	Design  Not applicable to 2008 NHIP	The existing recreational fields in the Central zone of campus shall be maintained and will continue to provide a buffer between campus development and the residential uses north of Sunset Boulevard.
PP 4.8-1(c)	Design	Infill development of the campus shall be continued, which reduces vehicle miles traveled and energy consumption.
PP 4.8-1(d)	Design	New building projects shall be sited to ensure compatibility with existing uses and the height and massing of adjacent facilities.
PP 4.8-1(e)	Design	Facilities shall be sited and designed to enhance spatial development of the campus while maximizing use of limited land resources.
<b>Noise and Vibration</b>		
PP 4.9-1	Design	The campus shall continue to evaluate ambient noise conditions when placing new student housing near regular sources of noise such as roadways, the on campus helistop, and stationary equipment and design the new buildings to ensure that interior noise levels would be less than 45 dBA CNEL.
PP 4.9-2	Construction	The campus shall continue to notify research facilities located near approved construction sites of the planned schedule of vibration causing activities so that the researchers can take necessary precautionary measures to avoid negative effects to their research.

## VI. Appendix A. LRDP EIR Mitigation Monitoring Program

MM and PP Number	Mitigation Timing	Mitigation Measure(s) (MMs) or Applicable Campus Programs, Practices, and Procedures (PPs)
PP 4.9-6(a)	Design	The campus shall continue to shield all new stationary sources of noise that would be located in close proximity to noise-sensitive buildings and uses.
PP 4.9-6(b)	Design	The campus shall continue to provide a landscaped buffer along the western, northern, and eastern edges of the main campus in order to maximize the distance between the roadways and new buildings and provide an acoustically soft environment. At a minimum, this environment can be provided by planting grass and other low landscaping.
PP 4.9-7(a)	Construction	To the extent feasible, construction activities shall be limited to 7:00 A.M. to 9:00 P.M. Monday through Friday, 8:00 A.M. to 6:00 P.M. on Saturday, and no construction on Sunday and national holidays, as appropriate, in order to minimize disruption to area residences surrounding the campus and to on-campus uses that are sensitive to noise.
PP 4.9-7(b)	Construction	The campus shall continue to require by contract specifications that construction equipment be required to be muffled or otherwise shielded. Contracts shall specify that engine-driven equipment be fitted with appropriate noise mufflers.
PP 4.9-7(c)	Construction	The campus shall continue to require that stationary construction equipment material and vehicle staging be placed to direct noise away from sensitive receptors.
PP 4.9-7(d)	Construction	The campus shall continue to conduct regular meetings with on-campus constituents to provide advance notice of construction activities in order to coordinate these activities with the academic calendar, scheduled events, and other situations, as needed.
PP 4.9-8	Construction	The campus shall continue to conduct meetings, as needed, with off-campus constituents that are affected by campus construction to provide advance notice of construction activities and ensure that the mutual needs of the particular construction project and of those impacted by construction noise are met, to the extent feasible.
MM 4.9-2	Pre-Construction and Construction  Not applicable to 2008 NHIP	The campus shall require by contract specifications that, to the extent feasible, large bulldozers, large heavy trucks, and other similar equipment not be used within 43 feet of the occupied residence halls, within 34 feet of non-residential/non-sensitive buildings, and within 135 feet of buildings that house sensitive instrumentation or similar vibration-sensitive equipment or activities. The work shall be done with medium-sized equipment or smaller within these prescribed distances to the extent practicable.
MM 4.9-7	Pre-Construction  Not applicable to 2008 NHIP	A solid noise barrier that would break the line of sight between the construction site and a sensitive use area would reduce construction noise by at least 5 dBA. Therefore, when detailed construction plans are complete, the campus shall review the locations of sensitive receptor areas in relation to the construction site. If it is determined that a 12-foot-high barrier would break the line of sight between an 11-foot-high noise source and adjacent sensitive use areas, a temporary barrier shall be erected to the extent practicable. The barrier shall be solid from the ground to the top, with no openings, and shall have a weight of at least 3 pounds per square foot, such as plywood that is ½-inch thick
<b>Population and Housing</b>		
Mitigation measures are not required.		
<b>Public Services</b>		
PP 4.11-1	Design	Fire alarm connections to the University Police Command Center shall continue to be provided in all new and renovated buildings to provide immediate location information to the Los Angeles Fire Department to reduce response times in emergency situations.
PP 4.11-2(a)	Design and Operation	Police staffing levels and equipment needs shall continue to be assessed on an ongoing basis as individual development projects are proposed and on an annual basis during the campus budgeting process to ensure that the appropriate service levels will be maintained to protect an increased campus population and an increased level of development.
PP 4.11-2(b)	Design and Operation	Annual meetings shall continue to be attended by the Director of UCLA Housing and the UCPD to evaluate the adequacy of police protection service for University-owned housing, assess institutional priorities and budgetary requirements, and identify and implement appropriate actions to ensure the continued adequacy of police protection services for resident students.

## VI. Appendix A. LRDP EIR Mitigation Monitoring Program

MM and PP Number	Mitigation Timing	Mitigation Measure(s) (MMs) or Applicable Campus Programs, Practices, and Procedures (PPs)
<b>Recreation</b>		
PP 4.12-1(a)	Design and Operation	The campus shall continue to provide, operate, and maintain recreational facilities for students, faculty, and staff on campus.
PP 4.12-1(b)	Design and Operation	The campus shall continue to integrate landscaped open space (including plazas, courts, gardens, walkways, and recreational areas) with development to encourage use through placement and design.
<b>Transportation/Traffic</b>		
PP 4.13-1(a)	Operation	The campus shall continue to maintain the 1990 LRDP vehicle trip cap of 139,500 average daily trips.
PP 4.13-1(b)	Operation	The campus shall continue to maintain the 1990 LRDP parking cap of 25,169 spaces.
PP 4.13-1(c)	Design and Operation	The campus shall continue to provide on-campus housing to continue the evolution of UCLA from a commuter to a residential campus.
PP 4.13-1(d)	Operation	The campus shall continue to implement a TDM program that meets or exceeds all trip reduction and AVR requirements of the SCAQMD. The TDM program may be subject to modification as new technologies are developed or alternate program elements are found to be more effective.
PP 4.13-2	Construction	UCLA Capital Programs will assess construction schedules of major projects to determine the potential for overlapping construction activities to result in periods of heavy construction vehicle traffic on individual roadway segments, and adjust construction schedules, work hours, or access routes to the extent feasible to reduce construction-related traffic congestion.
PP 4.13-5	Construction	To the extent feasible, the campus shall maintain at least one unobstructed lane in both directions on campus roadways. At any time only a single lane is available, the campus shall provide a temporary traffic signal, signal carriers (i.e., flagpersons), or other appropriate traffic controls to allow travel in both directions. If construction activities require the complete closure of a roadway segment, the campus shall provide appropriate signage indicating alternative routes.
PP 4.13-6	Construction	For any construction-related closure of pedestrian routes, the campus shall provide appropriate signage indicating alternative route and provide curb cuts and street crossings to assure alternate routes are accessible.
PP 4.13-8	Pre-construction and Construction	To ensure adequate access for emergency vehicles when construction projects would result in temporary lane or roadway closures, UCLA shall consult with the UCPD, EH&S, and the LAFD to disclose temporary lane or roadway closures and alternative travel routes.
MM 4.13-11	Construction	To the extent that construction worker parking demand exceeds historical levels or available supply, off-site construction worker parking shall be provided with shuttle service to the remote parking location.
<b>Utilities and Service Systems</b>		
PP 4.14-2(a)	Design	New facilities and renovations (except for patient care facilities in the Medical Center) shall be equipped with low-flow showers, toilets, and urinals.
PP 4.14-2(b)	Operation	Measures to reduce landscaping irrigation needs shall be used, such as automatic timing systems to apply irrigation water during times of the day when evaporation rates are low, installing drip irrigation systems, using mulch for landscaping, subscribing to the California Irrigation Management Information System Network for current information on weather and evaporation rates, and incorporating drought-resistant plants as appropriate.
PP 4.14-2(c)	Operation	The campus shall promptly detect and repair leaks in water and irrigation pipes.
PP 4.14-2(d)	Operation	The campus shall minimize the use of water to clean sidewalks, walkways, driveways, and parking areas.
PP 4.14-2(e)	Operation	The campus shall avoid serving water at UCLA food service facilities except upon request.

## VI. Appendix A. LRDP EIR Mitigation Monitoring Program

<b>MM and PP Number</b>	<b>Mitigation Timing</b>	<b>Mitigation Measure(s) (MMs) or Applicable Campus Programs, Practices, and Procedures (PPs)</b>
PP 4.14-2(f)	Operation	The campus shall provide ongoing water treatment programs for campus cooling equipment by adding biodegradable chemicals to achieve reductions in water usage.
PP 4.14-2(g)	Operation	The campus shall educate the campus community on the importance of water conservation measures.
PP 4.14-3	Operation	The campus shall continue to implement a solid waste reduction and recycling program designed to limit the total quantity of campus solid waste that is disposed of in landfills during the LRDP plan horizon.
PP 4.14-5	Design	As part of the design process for proposed projects, an evaluation of the on-campus sewer conveyance capacity shall be undertaken, and improvements provided if necessary in order to ensure that connections are adequate and capacity is available to accommodate estimated flows.
PP 4.14-9	Design and Operation	The campus shall continue to implement energy conservation measures (such as energy-efficient lighting and microprocessor-controlled HVAC equipment) to reduce the demand for electricity and natural gas. The energy conservation measures may be subject to modification as new technologies are developed or if current technologies become obsolete through replacement.
<b>Climate Change</b>		
PP 4.15-1	Design and Operation	The campus shall continue to implement provisions of the UC Policy on Sustainability Practices including, but not limited to: Green Building Design; Clean Energy Standards; Climate Protection Practices; Sustainable Transportation Practices; Sustainable Operations; Recycling and Waste Management; and Environmentally Preferable Purchasing Practices; and provisions of the applicable UCLA Climate Action Plan.

# VI. Appendix B. Architectural Guidelines

## Architectural Guidelines



University Of California Los Angeles  
Capital Programs Fall 2008

### Architectural Guidelines

**Street Sign**  
**Manufacturer:** Contact UCLA Facilities Sign Shop  
**Sign Description:** Porcelain coated steel w/ reflective white lettering  
**Color:** UCLA Brown  
**Font:** UCLA Gothic. Height 1 1/2"  
**Sign Dimension:** 30" x 9"  
**Pole Description:** Round steel pole w/ custom cap (See UCLA FSS)  
**Height:** 10' to top of pole  
**Color:** UCLA Brown exterior enamel paint

**Venue Directional Signs**  
**Manufacturer:** Contact UCLA Facilities Sign Shop  
**Description:** Exterior rated engraving plastic w/ white recessed lettering & arrow  
**Color:** UCLA Brown  
**Font:** UCLA Gothic Upper Case. Height 2"  
**Sign Dimensions:** 30" x 5"

**Directional Parking Sign**  
**Manufacturer:** Contact UCLA Facilities Sign Shop  
**Description:** Exterior rated engraving plastic w/ white inlaid letters  
**Color:** UCLA Brown  
**Font:** UCLA Gothic. Height - Contact UCLA Facilities Sign Shop  
**Sign Dimensions:** 10" x 12"

**Vicinity Map**  
**Manufacturer:** Contact UCLA Facilities Sign Shop  
**Holder Description:** Exterior rated engraving plastic w/ white inlaid letters (Lens-Matte Clear)  
**Color:** UCLA Brown  
**Font:** UCLA Gothic. Height 1 1/4"  
**Map Description:** Vinyl Resin - UV Stable for 5 years

### Directional Signage



Street Sign



Venue Direction Sign



Vicinity Map



Directional Parking Sign

## VI. Appendix B. Architectural Guidelines

### Architectural Guidelines

#### Blank Sign - Bicycle Parking (Example)

**Manufacturer:** Contact UCLA Facilities Sign Shop  
**Sign Description:** .080 Gauge aluminum w/ baked enamel finish

**Color:** Contact UCLA Facilities Sign Shop

**Font:** UCLA Gothic.

**Sign Dimension:**

Size A - 12" x 18" (1 5/8" Radius Corner)

Size B - 18" x 24" (1 5/8" Radius Corner)

**Pole Description:** 1 3/4" x 1 3/4" x 10' 14 gauge solid steel square tubing.

**Height:** 10' to top of pole

**Color:** UCLA Brown exterior enamel paint

**Installation:** Hole cut in concrete w/sleeve. Sleeve not to extend above ground plane more than 3"



### Architectural Guidelines

#### Vehicular Directional Sign

**Manufacturer:** Contact UCLA Facilities Sign Shop  
**Sign Description:** Internally illuminated, mounted on concrete base. Cut letters and push-through white translucent acrylic lettering.

**Color:** Exterior Box AKZO Nobel

Product Code - Color Map 493H1

Code # - GGHS CMAP 1927

Interior Face AKZO Nobel

Product Code -Color Map 181H2

Code # - Grip Card CMAP - 1689

**Font:** UCLA Gothic Upper/Lower Case

**Sign Dimensions:** 66.5" x 47.5" x 8"

**Base Description:** Poured in place concrete base.

**Color:** Miami Buff

**Height Above Ground Plane:** - 8"

### Vehicular Directional Signage



Directional Sign

#### Parking Sign

**Manufacturer:** Contact UCLA Facilities Sign Shop  
**Sign Description:** Internally illuminated, mounted on concrete base. Cut letters and push-through white translucent acrylic lettering.

**Color:** Exterior Box AKZO Nobel

Product Code - Color Map 493H1

Code # - GGHS CMAP 1927

Interior Face AKZO Nobel

Product Code -Color Map 181H2

Code # - Grip Card CMAP - 1689

**Font:** UCLA Gothic Upper/Lower Case

**Sign Dimensions:**

**Base Description:** Poured in place concrete base.

**Color:** Miami Buff

**Height Above Ground Plane:** - 8"



parking sign

# VI. Appendix B. Architectural Guidelines

## Architectural Guidelines

**Building Signs**  
 Manufacturer: Contact UCLA Facilities Sign Shop  
 Description: Solid brushed brass lettering  
 Font: UCLA Gothic Upper Case. Maximum Height 5", minimum height 3". Thickness 1/2"

## Building Signage



Brass Building Sign

**Building Sign - Adhesive Mylar on Glass**  
 Manufacturer: Contact UCLA Facilities Sign Shop  
 Description: Shiny gold mylar adhesive lettering  
 Font: UCLA Gothic Upper Case. Height 1 1/2"



Mylar Sign on Glass

**Building Sign - Incised Letters**  
 Manufacturer: TBC  
 Description: Incised lettering painted dark bronze or light grey.  
 Font: UCLA Gothic. Height 10"



Stone Incised Building Sign

## Architectural Guidelines

**Acorn Lamp Fixture**  
 Manufacturer: Sternberg Vintage Lighting  
 555 Lawrence Avenue  
 Roselle, IL 60172  
 P 847.588.3400  
 F 847.588.3440  
 1.800.621.3376  
 www.sternberg.com

Description - Avenue B750/508 s/polished brass decorative ring. Acrylic DR 15" x 22" street acorn with authentic "glasslike" look mounted on historic fluted and flared fitter. The complete fixture scale 15" x 22" with integral ballast and optional glass refractor/Alzak reflector combination or louver optics.  
 Base: Oxford (6200 TFP)  
 Height : 12' Pole  
 Color: Dark Antique Brown

**ENERGY STAR NightSky Optical Systems**  
 Manufacturer: Sternberg Lighting (See Above)  
 Description -  
 Type III Asymmetric Vertical Lamp NightSky Louver  
 Use: Street, pathways and sidewalks

ORDER NUMBER:  
 B750A/SP/PBDR/LO3/150HPS-Wire to Voltage -  
 MT/6212TFP/DB

Type V Round Vertical Lamp NightSky Louver  
 Use: Where pathways or streets cross and for general parking lot lighting.

ORDER NUMBER:  
 B750A/SP/PBDR/LO5/150HPS-Wire to Voltage -  
 MT/6212TFP/DB

## Light Standard



Acorn Lamp Fixture



OPTI-SHIELD - LO3-S (LO5-S)  
 Louvre Optics Type III of V



# VI. Appendix B. Architectural Guidelines

## Architectural Guidelines

### Wood Site Furniture

**Manufacturer:** British American Collection  
 124 Wallace Avenue  
 Downingtown, PA 19335  
 P 800.344.0259

**Description:** Wooden Bench & Chair - Medway  
 Wooden Table & Stool - Wimbledon  
 Pieces are a natural finish, handcrafted from kiln-dried, solid teak.

## Wood Site Furniture



## Architectural Guidelines

### Metal Chair and Table Set

**Manufacturer:** Prototech Metal Inc.  
 5449 N. Peck Road  
 Arcadia, CA 91006  
 P 626.443.1796 or 323.283.8491  
 F 626.443.1798

**Description:**

**Chairs** - 100% Heli-Arc Welded. Frames are 1/8" x 3/4" x 1 1/2" CRS tube. Seat and Back are 14 GA. CRS Perforated Steel

**Tables** - 100% Heli-Arc Welded. Frames are 1/8" x 1" x 1 1/2" CRS tubing. Table top is 14 GA CRS perforated metal w/ or w/o umbrella hole.

**Coating/Color** - All tables and chairs are to be 100% powder coated. Frames - Charles E Young Brown. Perforated seat, back rest and table top- Dunn Edwards, Sterling Silver SP28.

## Metal Site Furniture



Metal Chair and Table Set

### Pasadena Metal Ribbon Bench

**Manufacturer:** Victor Stanley, Inc.  
 Brick House Road  
 Dunkirk, Maryland 20754  
 P 800.368.2573  
 F 410.257.7579  
[www.victorstanley.com](http://www.victorstanley.com)

**Description:** CR-10 Classic Series ductile iron frames with steel ribbon seating.

**Color:** UCLA Brown



Pasadena Bench

# VI. Appendix B. Architectural Guidelines

## Architectural Guidelines

To Be Confirmed

## Concrete Site Furniture



## Architectural Guidelines

### Metal Ribbon Trash Receptacle

**Manufacturer:** Victor Stanley, Inc.  
 Brick House Road  
 Dunkirk, Maryland 20754  
 P 800.368.2573  
 F 410.257.7579  
 www.victorstanley.com

**Description:** Model S-424. Heavy 3/8" thick solid steel bars are formed and welded to define a profile which provides enormous strength. Dark Bronze powder coated finish.

### Stand Alone Ash Urn

**Manufacturer:** Victor Stanley, Inc.  
 Brick House Road  
 Dunkirk, Maryland 20754  
 P 800.368.2573  
 F 410.257.7579  
 www.victorstanley.com

**Description:** Model S-20. 3/8" thick solid steel bars formed and welded. Dark Bronze powder coated finish. Comes with stainless steel ash tray.

### Recycle Receptacles

**Manufacturer:** Victor Stanley, Inc.  
 Brick House Road  
 Dunkirk, Maryland 20754  
 P 800.368.2573  
 F 410.257.7579  
 www.victorstanley.com

**Description:** Model S-424. 3/8" thick solid steel bars formed and welded. Dark bronze powder coated finish. Lid and receptacle combinations are available.

## Trash Receptacles



Metal Ribbon Trash Receptacle



Stand Alone Ash Urn



Recycle Receptacles

# VI. Appendix B. Architectural Guidelines

## Architectural Guidelines

### Inverted U Bicycle Racks

**Manufacturer:** Creative Pipe, Inc.  
 P.O. Box 2458  
 Rancho Mirage, CA 91170-1087  
 P 800.644.8467  
 F 760.340.5883  
 www@creativepipe.com

**Material:** 1-5/8" O.D. Schedule 40 Steel Pipe  
**Powder coated (P)**

**Color:** Bronze  
Gauntlet GL Series Available in 34", 64", 94", 124", 154", 184"

**Locations -** Used in locations which provide landscape buffer.

Inverted U - Model SU20-E-P (Dark Bronze)  
 Available in 22" length

**Locations -** Used in street and path locations with no landscape buffer

All new bike locations, models and layouts must be approved by Campus Architect

## Bicycle Racks



GL 3-SM-P

Gauntlet GL Series



SU 20-E-F  
 DARK BRONZE

Inverted "U"

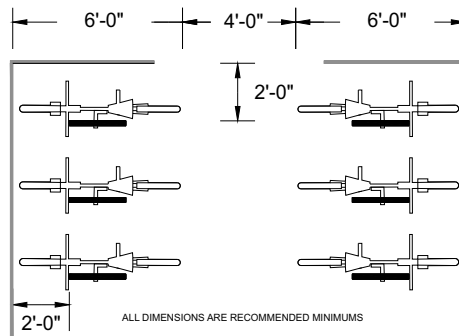

## Architectural Guidelines

### Trench Drain

**Manufacturer:** Urban Accessories, Inc.  
 Post Office Box 310  
 20004 144th Ave. NE  
 Woodinville, Washington 98072  
 P 425.487.0488  
 F 425.485.6618  
 www.urbanaccessories.com

**Description:** Tidal Wave Style, Standard Finish-Raw Cast Iron per ASTM A48 class 35B or better.



Trench Drain

### Bollard Luminaire

**Manufacturer:** Bega  
**Description:** Die cast aluminum cap and louvers "keyed" to post. Clear prism glass with screw neck. Bollards are secured to a cast aluminum baseplate with four stainless steel bolts at 90 degrees. Custom color to match UCLA brown.  
**Base Description:** Poured in place concrete base.  
**Color -** Miami Buff



### Retractable Bollard

**Manufacturer:** TBC  
**Description:** TBC

### Removable Bollards

**Manufacturer:** TBC  
**Description:** TBC

### Fixed Bollards

**Manufacturer:** TBC  
**Description:** TBC

## Street Accessories

# VI. Appendix B. Architectural Guidelines

## Architectural Guidelines

### Vending Kiosk



Vending Kiosk

## Vending Kiosk

## Architectural Guidelines

### UCLA Blend Brick

**Manufacturer:** Pacific Clay Products Inc.  
14741 Lake Street.  
Lake Elsinore, Ca 92530  
P 909.674.2131  
www.pacificclay.com

**Description:**  
Colors - #190 (24%), #590 Light (16%), Rose Tan (20%)  
Imperial Peach (40%)  
Texture - Ruffle Finish @ all exposed sides  
Coursing - 4" Offset Running Bond  
Size - Norman Brick (11 1/2"x3 1/2"x2 3/16")  
Accent Brick Color - #590 Dark

### UCLA Clay Block

**Manufacturer:** Pacific Clay Products Inc.  
**Description:**  
Color - Westwood Buff  
Texture - Velour  
Coursing - 4" Offset Running Bond  
Size - 12"x8"x4" Nominal Clay Block

### Mortar (Brick & Block)

**Manufacturer:** Spec Mix  
**Description:**  
Color - #437 Type S  
Joint Style - Tooled Joint (Slightly Concave)

### UCLA Standard Exterior Paint

**Manufacturer:** Benjamin Moore  
**Description:**  
Color - Benjamin Moore Historical Color 79  
Alternate Color - BM HC 82

### Brick Control Joint

**Description:**  
Zipper Joint - Sealant joint dusted w/mortar sand to match mortar joint. Optional.

## Standard Materials

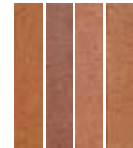
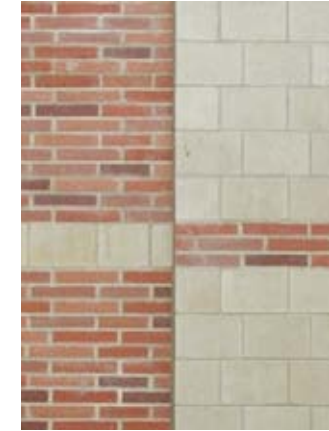

UCLA Blend Brick



BM HC 79  
On textured plaster



Brick Control Joint

# VI. Appendix B. Architectural Guidelines

## Architectural Guidelines

### Building Elements - Roof Materials

#### Roof Ballast

Description:  
Color - Crushed Brick



Gravel Roof

#### Clay Tile Roofing

Manufacturer: Gladding McBean  
601 7th Street  
Lincoln, CA 95648-1828  
P 800.776.1133  
F 916.645.1723  
www.gladdingmcbean.pacocoast.com  
Description: Cordova Cover w/Italian Pan  
Dimension - Italian Pan (12"wide x 18"long x 2"high)  
Cordova Cover (8" x 18" long)  
Color - Italian Pan (100% Red)  
Cordova Cover (70% Monterey Blend/30% Red)



Clay Tile Roofing

#### Standing Seam Metal Roofing

Description:  
Color - UCLA Brown



Standing Seam Metal Roofing

### Building Elements - Window Mullion

#### Window Mullion

Description:  
Material - Aluminum/Kynar Finish  
Color - Tan variations close to  
BM HC 79,82,80 and/or 92)



Aluminum Window

## Architectural Guidelines

### Building Elements - Down Spouts

#### Down Spout/Gutter/Flashing (If exposed)

Description:  
Material - Aluminum, painted galvanized sheet metal, or copper.  
Color - To Match Building Metal Work

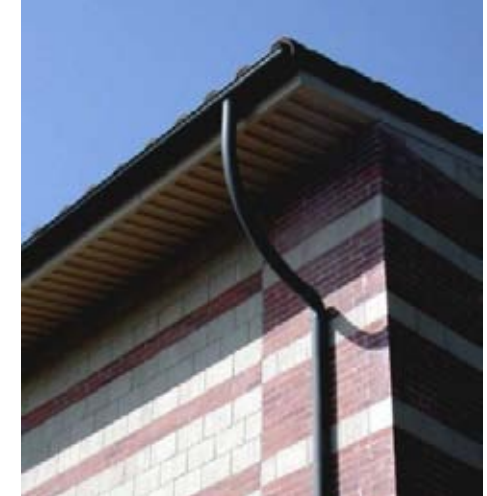

Copper Down Spout

# VI. Appendix B. Architectural Guidelines

## Architectural Guidelines

### Building Elements - Hardscape

#### Brick Hardscape - Example Haines Hall

**Description:**  
UCLA Blend Norman Brick w/ Medallions  
Ruffle Texture @ exposed sides (23/16" Face Up),  
set in rowlock

Poured in Place Concrete. Broom Finish, scored joints.  
Miami Buff by Davis Colors  
Formula: 1 lbs. Of No. 5447  
(Per 94lb. Bag of Portland Type I-II Cement)

**Mortar (Brick)**  
**Manufacturer:** Spec Mix  
**Description:**  
Color - #437 Type S  
Joint Style - Flush

#### Brick Walkway - Example Anderson School

**Description:**  
UCLA Blend Norman Brick w/ Medallions  
Ruffle Texture @ exposed sides (4" Face Up),  
set in rowlock

Pre-cast Concrete Pavers over structural concrete slab.  
Color: Miami Buff by Davis Colors  
Davis Colors  
3700 E. Olympic Blvd.  
Los Angeles, CA 90023-3123  
P 800.356.4848  
F 323.269.1053  
www.daviscolors.com

**Mortar**  
**Manufacturer:** Spec Mix  
www.specmix.com  
**Description:**  
Color - #437 Type S  
Joint Style - Flush

#### Brick Disabled Access Walk

**Description:**  
UCLA Blend Norman Brick w/ Medallions  
Ruffle Texture @ exposed sides (23/16" Face Up),  
set in rowlock

Poured in Place Concrete. Broom Finish  
Miami Buff by Davis Colors

**Mortar**  
**Manufacturer:** Spec Mix  
**Description:**  
Color - #437 Type S  
Joint Style - Flush

\*\* Variations in hardscape pattern design must be approved by Campus Architect

## Building Elements



Context

Brick and Concrete Walkway



Context

Brick and Precast Concrete Hardscape



Context

Brick and Concrete Disabled Access Walk

## Architectural Guidelines

### Exterior Wall Elevations

Elevation pattern variations utilizing UCLA Blend Brick & UCLA Clay Block, Terra Cottaor Pre-Cast Concrete.

## Exterior Wall Elevations



UCLA Blend Brick and terra cotta detailing - Powell Library



UCLA Blend Brick with precast concrete detailing - Anderson Graduate School



UCLA Blend Brick with westwood buff clay block - Wooden Center North



Powell Library



This booklet is printed on BOISE ASPEN 100 Premium Recycled Paper, which is 100% Recycled, made of 100% Post-Consumer Content and without the use of chlorine or chlorine compounds.